

**SERVICE AND INSTALLATION
MANUAL**



**SPLIT INVERTER
AIR TO WATER HEAT PUMPS**

GSH-80IRB + GSH-80ERB
GSH-100IRB + GSH-100ERB



Contents

ENGINEERING DATA	1
1 Product Data.....	2
1.1 Lineup.....	2
1.2 Nomenclature.....	3
1.3 Product Features.....	4
1.4 Operating Principle	7
1.5 Technical Data	8
2 Outline Dimensions	12
3 Explosive Views and Part Lists	14
4 Supply Scope	18
DESIGN & SELECTION	19
1 Installation Example	20
2 Model Selection.....	23
2.1 Speculations of Power Supply	23
2.2 Operation Conditions	23
2.3 Flowchart of Model Selection.....	23
2.4 Design Principle	23
3 Selection of the Underfloor Coils.....	24
3.1 Calculation of Unit Load for Floor Heating.....	24
3.2 Selection of Tube Spacing of the Underfloor Coils.....	24
3.3 Selection of Loop Quantity of Coils for Each Room	25
4 Quantity and Location of the Water Traps and Collectors.....	25
4.1 Design Requirements on Loop Quantity for Circulation Water	26
4.2 Requirements on Installation of the Water Trap (Collector)	27
5 Section of FCU	27
5.1 FCU Type Selection	27
5.2 Matching of Capacity	27
6 Selection of the Water Tank.....	29
6.1 Specifications of the Water Tank	29
6.2 Volume Selection of the Water Tank	29
7 Examples for Model Selection.....	30
7.1 General Introduction to the Example Project.....	30
7.2 Heat Load Calculation.....	30
7.3 Model Selection.....	32
UNIT CONTROL	33
1 Integral Control Concept	34
1.1 Control Principle Diagram	34
1.2 Control Flowchart.....	37
2 Main Control Logics.....	37
2.1 Cooling	37
2.2 Heating	38
2.3 Water Heating	38
2.4 Shutdown	39
2.5 Control to the Compressor.....	39

2.6 Control to the Fan	40
2.7 Control to the 4-way Valve.....	40
2.8 Control to the Water Pump	40
2.9 Control the Electrostatic Expansion Valve.....	40
2.10 Protection Control	40
3 Controller	41
3.1 General.....	41
3.2 Operation Instructions.....	45
3.3 Intelligent Control	75
UNIT INSTALLATION.....	87
1. Installation Guides.....	88
1.1 Installation Position	89
1.2 Matters Need Attention	89
2 Filed Supplied Pipes and Valves.....	90
3 Service Tools.....	91
4 Instalaltion Instructions.....	92
4.1 Installation Examples	92
4.2 Pre-Installation	94
4.3 Selection of Installation Location	95
4.4 Outline Dimension of Outdoor Unit.....	96
4.5 Installation of Outdoor Unit	98
4.6 Installation of Indoor Unit	102
4.7 Connection of Pipeline	110
4.8 Installation of Water Tank	112
4.9 Requirements on water quality	116
4.10 Electric Wiring	117
4.11 Wiring of the Terminal Board.....	119
4.12 Wiring of the 2-Way Valve	120
4.13 Wiring of Other Thermal.....	120
4.14 Wiring of the Gate-Controller.....	122
4.15 Wiring of the Remote Air Temperature Sensor	122
4.16 Wiring of the Thermostat.....	124
4.17 Wiring of the Control	124
5 Commissioning and Trial Run	125
5.1 Check before startup.....	125
5.2 Test run	126
TEST OPERATION & TROUBLESHOOTING & MAINTENANCE.....	128
1 Trial Run	129
1.1 Check for Wiring.....	129
1.2 Check for the Water System.....	129
1.3 Check for the Communication System	129
1.4 Trial Run.....	129
2 Error Code List	129
3 Flow Chart of Troubleshooting	132
3.1 Comp High-pressure Protection E1	132
3.2 Comp Low- pressure Protection E3.....	133

3.3 Comp Discharge Temp Protection E4	133
3.4 Overload Protection of Compressor or Driver Error	134
3.5 DC Fan Error EF	134
3.6 Temperature Sensor Error	135
3.7 Communication Malfunction E6	135
3.8 Capacity Switch Error (Code:"C5")	136
4 Diagnosis of Driving	136
4.1 Diagnosis Flowchart of Driving of Single-phase Unit and Three-phase Unit	136
5 Daily Maintenance and Repair	140
5.1 Daily Maintenance	140
5.2 Troubleshooting	140
5.3 Repair	142

ENGINEERING DATA

1 Product Data

1.1 Lineup

1.1.1 Main Unit

Model	Heating capacity	Cooling capacity	Power supply	Refrigerant	Appearance
GSH-80IRB + GSH-80ERB	8	7	220-240V, ~, 50Hz	R32	
GSH-100IRB + GSH-100ERB	9,5	8,5			

1.3 Product Features

1.3.1 General

It's a kind of integrated DC inverter unit that comprises cooling, heating and water heating functions, and up to 5.0 energy efficiency. It adopts R32 refrigerant and two-stage compressor. For heating, ambient temperature range is $-25\sim 35^{\circ}\text{C}$ while the leaving water temperature range is $20\sim 60^{\circ}\text{C}$.

The S-Therm unit is designed specially for the European market where there is a demand for high-temperature water. Thanks to the dual-stage compression and enthalpy gain through gas injection, the heating energy efficiency at low temperature will rise up greatly with the leaving water temperature up to 60°C . The whole series of products strictly comply with EN14511, EUROVENT energy efficiency Class A and SCOP class A+++ (35°C), SCOP class A++ (55°C) with EN14825. Their COP can reach up to 5.0. This unit can realize space heating and sanitary hot water supply through terminal units, like the fan coil unit, floor coil and radiator. Environment-friendly refrigerant R32 is adopted for the unit, with ODP of 0 and quite low GWP ($=675$). Besides, the adopted heat pump technologies will reduce consumption of coal and other energy source and lower greatly CO₂ emission. Ranged from 4.0kW~9.5kW, it is widely applicable to small and medium-sized apartment, large-sized villa etc.

1.3.2 Features

◆ Wide Operation Range

Heating: -25~35°C; Cooling: 10~48°C; Water Heating: -25~45°C

◆ Unique Low-Temp Hi-heat Dual-stage Compressor

1. Under low-temperature conditions, compared with the conventional compressor, the dual-stage low-temp hi-heat compressor will generate less loss of heat capacity and get higher energy efficiency.

2. Floodback, high discharge temperature and other problems can be completely avoided under low-temp conditions and the compressor's reliability will be enhanced greatly.

3. Dual-stage compression, dual-stage throttling and intermediate enthalpy adding through gas injection will raise the leaving water temperature and improve the control accuracy.

4. Values of resistance to compressor status:

4/6kW——UV/VW/UW: $1.67 \pm 7\% \Omega$;

8/10kW——UV/VW/UW: $0.99 \pm 7\% \Omega$

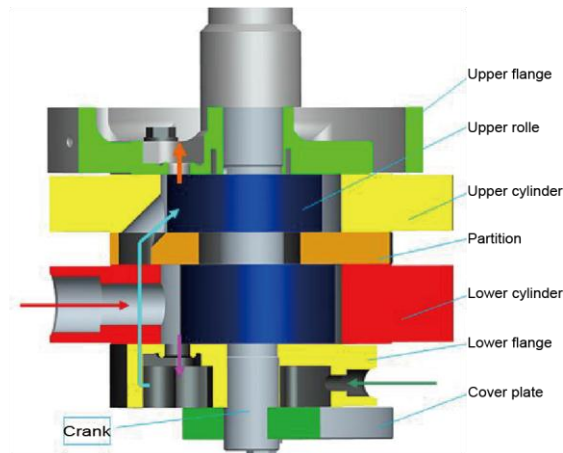

◆ High-efficiency Component(Inverter pump, Inverter fan, Plate heat exchanger)

1. The A-class high-efficiency inverter water pump which complies with the European ErP directive, can control the running frequency based on the actual load. Therefore, it can enhance the operation efficiency and control the water temperature more accurately.

2. The DC inverter fan can control the air volume accurately and make the system run more stably and save more energy.

3. The high-efficiency plate heat exchanger will improve the unit's performance largely.



4. The high-efficiency water pump will also improve the unit's performance largely.



◆ All-in-one Design

1. The unit can integrate with terminal units, like the radiator, floor heating device, FCU, water heating device, solar kit, gas furnace etc. Versatile functions can meet various kinds of demands from different users and enhance applicability of this product.

2. The all-in-one structure design can save more installation cost, reduce risks of refrigerant leak, and improve safety and reliability of the system.

◆ Brand-new Controller

1. White appearance, exquisite design, and the wall-mounted design will facilitate installation.

2. Liquid crystal display and touch-screen operation

3. The 12V JACK interface can supply power to the control separately and lengthen the communication distance.

4. The remote monitoring interface can monitor the unit through the Modbus interface and be integrated into the BMS system.



(Home page)



(Menu page)

◆ Smart Control, Powerful Function

1. The running mode can be switched freely. Furthermore, based on different demands, the holiday mode, weather-dependent mode, quiet timer, temperature timer and floor commissioning can be activated.

2. Multiple protections can make this product much safer. The added electric heater will prevent the plate heat exchanger from being frostbitten owing to too low water temperature and resultantly extend the service life of the product and enhance its safety and reliability.

3. The newly developed smart defrosting control program, “do defrost when necessary; do not defrost when unnecessary; defrost more when it frosts heavily; defrost less when it frosts lightly”, can bring more comfortability, avoid inadequacy of heat supply and ensure sustainable heat supply for the users.

- ◆ The flowchart with parameters to be set

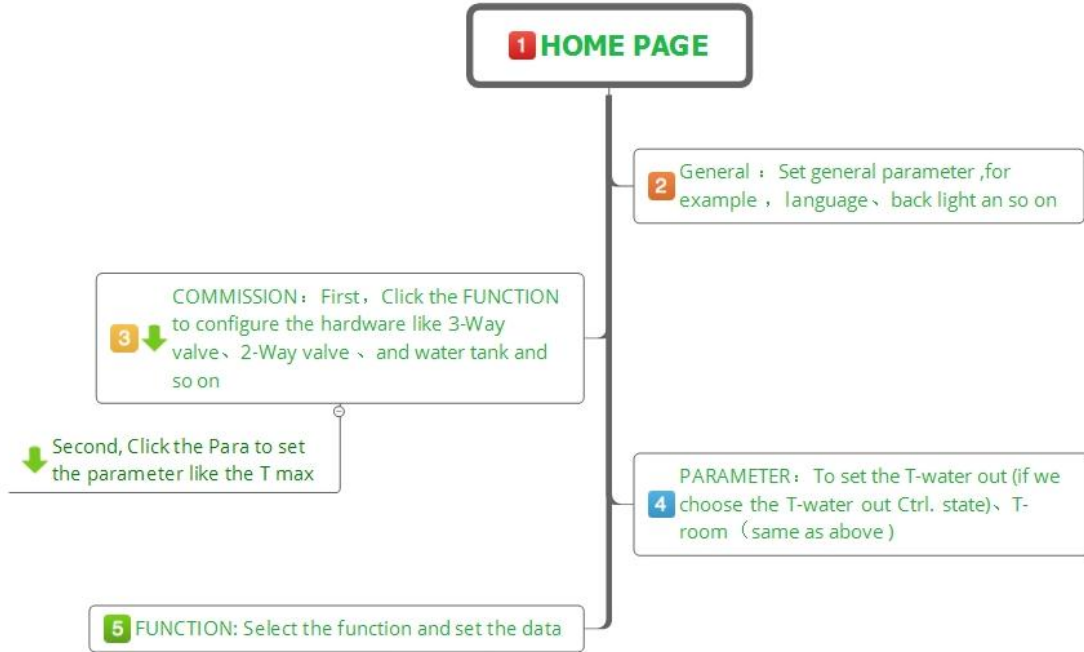

1.4 Operating Principle

1.4.1 Schematic Diagram

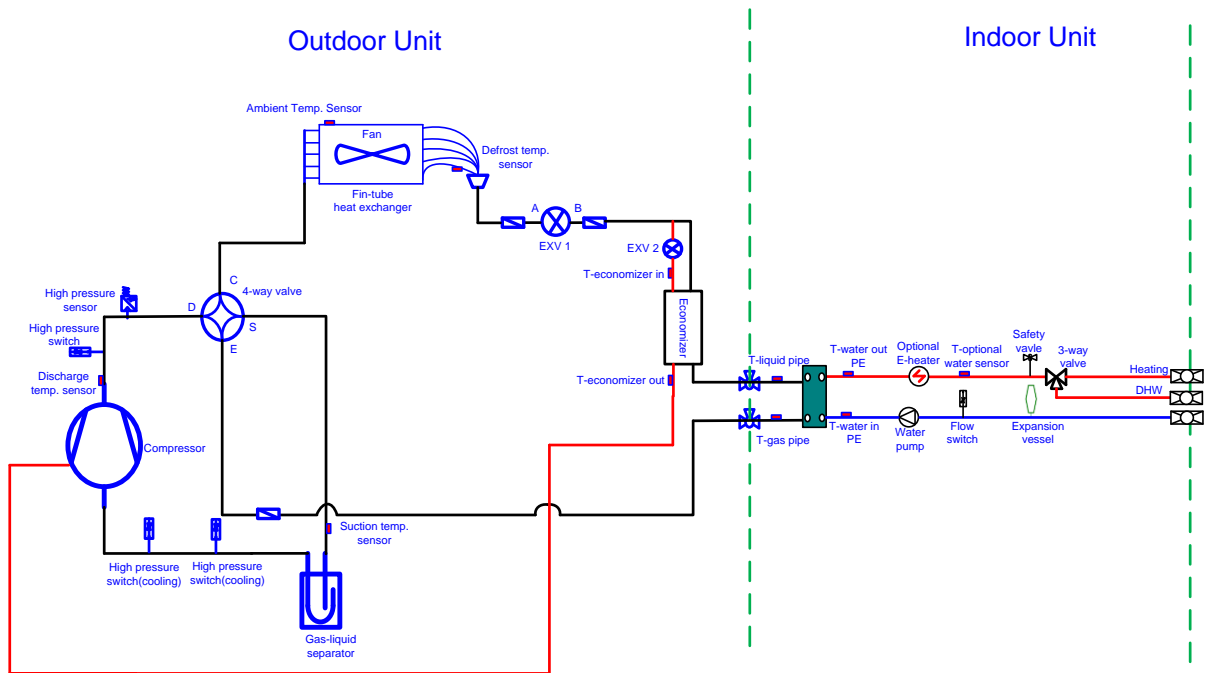

Note: the swimming pool, solar kit and water mixing accessory are optional parts. When they are required, please contact the manufacturer.

1.5 Technical Data

1.5.1 Parameter List

Model			GSH-80IRB	GSH-100IRB
Capacity*1	Cooling(floor cooling)	kW	7.0	8.5
	Heating(floor heating)	kW	8.0	9.5
Power Input*1	Cooling(floor cooling)	kW	1.75	2.24
	Heating(floor heating)	kW	1.70	2.07
EER*1(floor cooling)		W/W	4.0	3.8
COP*1(floor heating)		W/W	4.7	4.6
Capacity*2	Cooling(for Fan coil)	kW	5.3	6.5
	Heating(Fan coil or Radiator)	kW	8	9.5
Power Input*2	Cooling(for Fan coil)	kW	1.73	2.27
	Heating(Fan coil or Radiator)	kW	2.14	2.64
EER*2(for Fan coil)		W/W	3.0	2.9
COP*2(Fan coil or Radiator)		W/W	3.7	3.6
Refrigerant charge volume		kg	1.6	1.6
Sanitary water Temperature		°C	40~80°C	

Model			GSH-80IRB	GSH-100IRB
Sound Pressure Level	cooling	dB(A)	55	55
	heating	dB(A)	55	55
Dimensions (WxDxH)	Outline	mm	982x427x787	982x427x787
	Packaged	mm	1097x478x937	1094x478x937
Net weight/Gross weight		kg	82/92	82/92

Model			GSH-80IRB	GSH-100IRB
Sound Pressure Level	cooling	dB(A)	29	29
	heating	dB(A)	29	29

Engineering Data

Dimensions	Outline	mm	460×318×860	460×318×860
(W×D×H)	Packaged	mm	565×375×1130	565×375×1130
Net weight/Gross weight		kg	62/71	62/71

Notes

“*1” indicates the capacity and power input are tested based on the conditions below:

(1) Cooling

Indoor Water Temperature: 23°C/18°C; Outdoor Temperature: 35°CDB/24°CWB

(2) Heating

Indoor Water Temperature: 30°C/35°C; Outdoor Temperature: 7°CDB/6°CWB

“*2” indicates the capacity and power input are tested based on the conditions below:

(1) Cooling

Indoor Water Temperature: 12°C/7°C; Outdoor Temperature: 35°CDB/24°CWB

(2) Heating

Indoor Water Temperature: 40°C/45°C; Outdoor Temperature: 7°CDB/6°CWB

1.5.2 Nominal Working Conditions

Item	Water Side		Heat Source/User Side	
	Entering Water Temp (°C)	Leaving Water Temperature (°C)	Dry Bulb Temperature (°C)	Wet Bulb Temperature (°C)
FCU Cooling	12	7	35	—
FCU Heating	40	45	7	6
Floor Cooling	23	18	35	—
Floor Heating	30	35	7	6
Water Heating	53	-	7	6

1.5.3 Operation Range

Item	Water Side	Heat Source/User Side
	Leaving Water Temperature (°C)	Environment Dry Bulb Temperature (°C)
Cooling	7~25	10~48
Heating	20~60	-25~35
Water Heating	40~80 (Water Tank Temperature)	-25~45

Note: when operating conditions are out of the range listed above, please contact Sinclair.

1.5.4 Temperature sensor parameter

Displayed Name	inspection range(°C)	Nominal working datas			Remark
		Cooling	Heating	Hot water	
T-outdoor	-30~150	8~50	-27~37	-27~45	temperature sensor resistance 15K
T-suction	-30~150	5~30	-25~20	-25~30	temperature sensor resistance 20K
T-discharge	-30~150	30~102	35~102	35~102	temperature sensor resistance 50K
T-defrost	-30~150	20~57	-25~30	-25~40	temperature sensor resistance 20K
T-water in PE	-30~150	10~30	20~55	20~55	temperature sensor resistance 20K
T-water out PE	-30~150	5~25	25~60	25~60	temperature sensor resistance 20K
T-optional water Sen.	-30~150	5~25	25~60	25~60	temperature sensor resistance 50K

Engineering Data

T-tank ctrl.	-30~150	/	/	10~80	temperature sensor resistance 50K
T-floor debug	-30~150	/	25~45	/	/
Debug time	-30~150	/	12~72	/	/
T-liquid pipe	-30~150	5~25	20~57	20~57	temperature sensor resistance 20K
T-gas pipe	-30~150	30~102	35~102	35~102	temperature sensor resistance 20K
T-economizer in	-30~150	no EVI under cooling	-20~55	-20~55	temperature sensor resistance 20K
T-economizer out	-30~150	no EVI under cooling	-20~55	-20~55	temperature sensor resistance 20K
T-remote room	-30~150	18~30	18~30	18~30	/
Dis. Pressure	-40~70	25~60	25~62	25~62	/
T-weather depend	-30~150	7~25	25~60	/	based on calculation

1.5.5 Electric Data

Model	Power Supply	Air Break Switch	Minimum Section Area of Earth Wire	Minimum Section Area of Power Wire
	V, Ph, Hz	A	mm ²	mm ²
	230VAC, 1Ph, 50Hz			
GSH-80IRB		40	6.0	2*6.0
GSH-100IRB		40	6.0	2*6.0
	230VAC, 1Ph, 50Hz			
GSH-80ERB		25	4.0	2*4.0
GSH-100ERB		25	4.0	2*4.0

Notes

- ① Leakage Switch is necessary for additional installation. If circuit breakers with leakage protection are in use, action response time must be less than 0.1 second, leakage circuit must be 30mA.
- ② The above selected power cable diameters are determined based on assumption of distance from the distribution cabinet to the unit less than 75m. If cables are laid out in a distance of 75m to 150m, diameter of power cable must be increased to a further grade.
- ③ The power supply must be of rated voltage of the unit and special electrical line for air-conditioning.
- ④ All electrical installation shall be carried out by professional technicians in accordance with the local laws and regulations.
- ⑤ Ensure safe grounding and the grounding wire shall be connected with the special grounding equipment of the building and must be installed by professional technicians.
- ⑥ The specifications of the breaker and power cable listed in the table above are determined based on the maximum power (maximum amps) of the unit.
- ⑦ The specifications of the power cable listed in the table above are applied to the conduit-guarded multi-wire copper cable (like, YJV XLPE insulated power cable) used at 40°C

and resistible to 90°C (see IEC 60364-5-52). If the working condition changes, they should be modified according to the related national standard.

- ⑧ The specifications of the breaker listed in the table above are applied to the breaker with the working temperature at 40°C. If the working condition changes, they should be modified according to the related national standard.

1.5.5 Capacity Correction

- ◆ Cooling Capacity Correction
GSH-80ERB, GSH-100ERB

Performance correction					
Leaving Chilled Water °C(°F)	Ambient Temperature °C(°F)				
	25(77)	30(86)	35(95)	40(104)	45(113)
5(41.0)	0.995	0.955	0.905	0.855	0.805
6(42.8)	1.045	1.005	0.955	0.905	0.855
7(44.6)	1.090	1.050	1.000	0.950	0.900
8(46.4)	1.145	1.102	1.052	1.000	0.950
9(48.2)	1.190	1.150	1.100	1.050	1.002
10(50.0)	1.245	1.200	1.150	1.100	1.050
11(51.8)	1.290	1.250	1.202	1.152	1.102
12(53.6)	1.340	1.300	1.252	1.200	1.152
13(55.4)	1.390	1.350	1.302	1.252	1.202
14(57.2)	1.442	1.402	1.350	1.302	1.252
15(59.0)	1.490	1.450	1.400	1.350	1.302
18(64.4)	1.539	1.502	1.451	1.402	1.350

Computer of actual cooling capacity: actual cooling capacity = nominal cooling capacity x cooling capacity correction coefficient.

- ◆ Heating Capacity Correction
GSH-80ERB, GSH-100ERB

Performance Correction									
Outflow Heated Water °C(°F)	Ambient Temperature °C(°F)								
	-15(5)	-10(14)	-5(23)	0(32)	5(41.0)	10(50)	15(59.0)	20(68.0)	25(77.4)
30(86)	0.81	0.91	1.00	1.10	1.18	1.26	1.35	1.41	1.45
35(95)	0.74	0.84	0.93	1.03	1.11	1.19	1.28	1.36	1.41
40(104)	0.67	0.77	0.87	0.96	1.04	1.12	1.20	1.25	1.31
45(113)	0.60	0.70	0.80	0.89	0.97	1.05	1.13	1.19	1.25
50(122)	0.53	0.63	0.73	0.82	0.90	0.98	1.06	1.11	1.18
55(131)	0.46	0.56	0.66	0.74	0.83	0.90	0.98	1.05	1.10

Computer of actual heating capacity: actual heating capacity = nominal heating capacity x heating capacity correction coefficient.

2 Outline Dimensions

- ◆ GSH-80IRB, GSH-100IRB

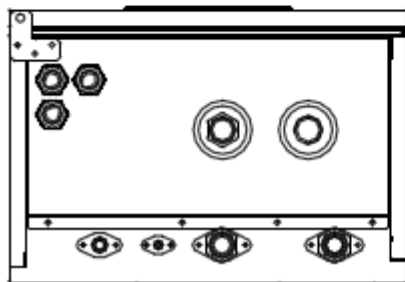
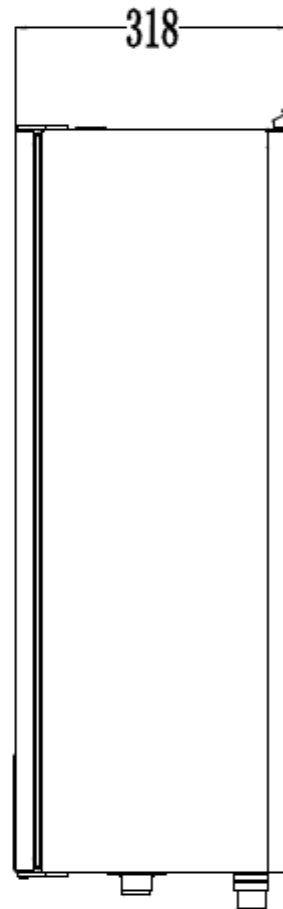
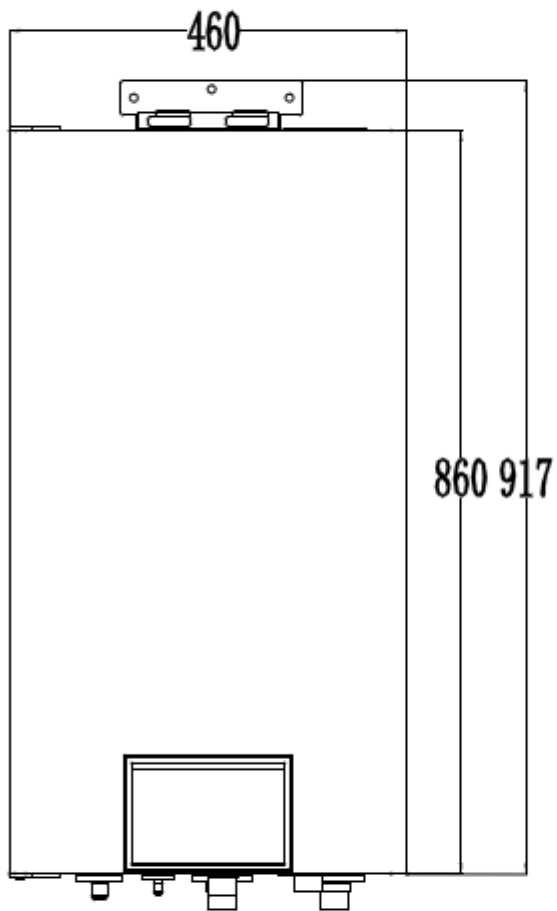
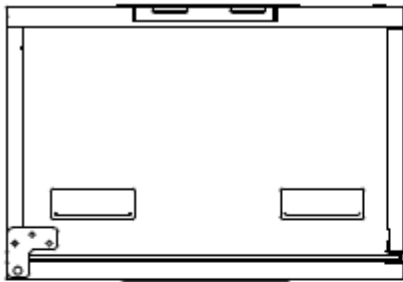

◆ GSH-80ERB, GSH-100ERB

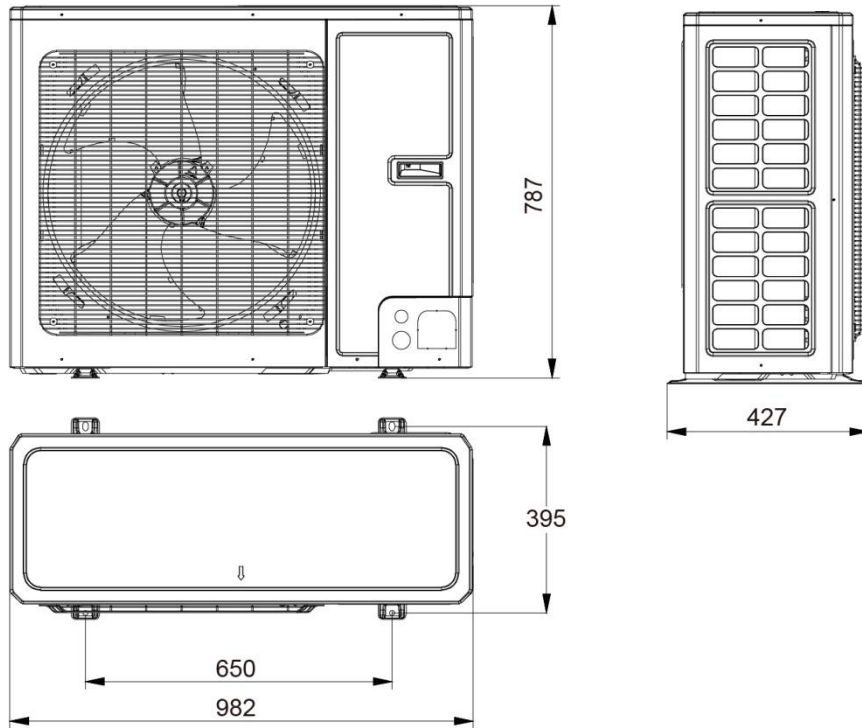

3 Explosive Views and Part Lists

SMH-80IRB

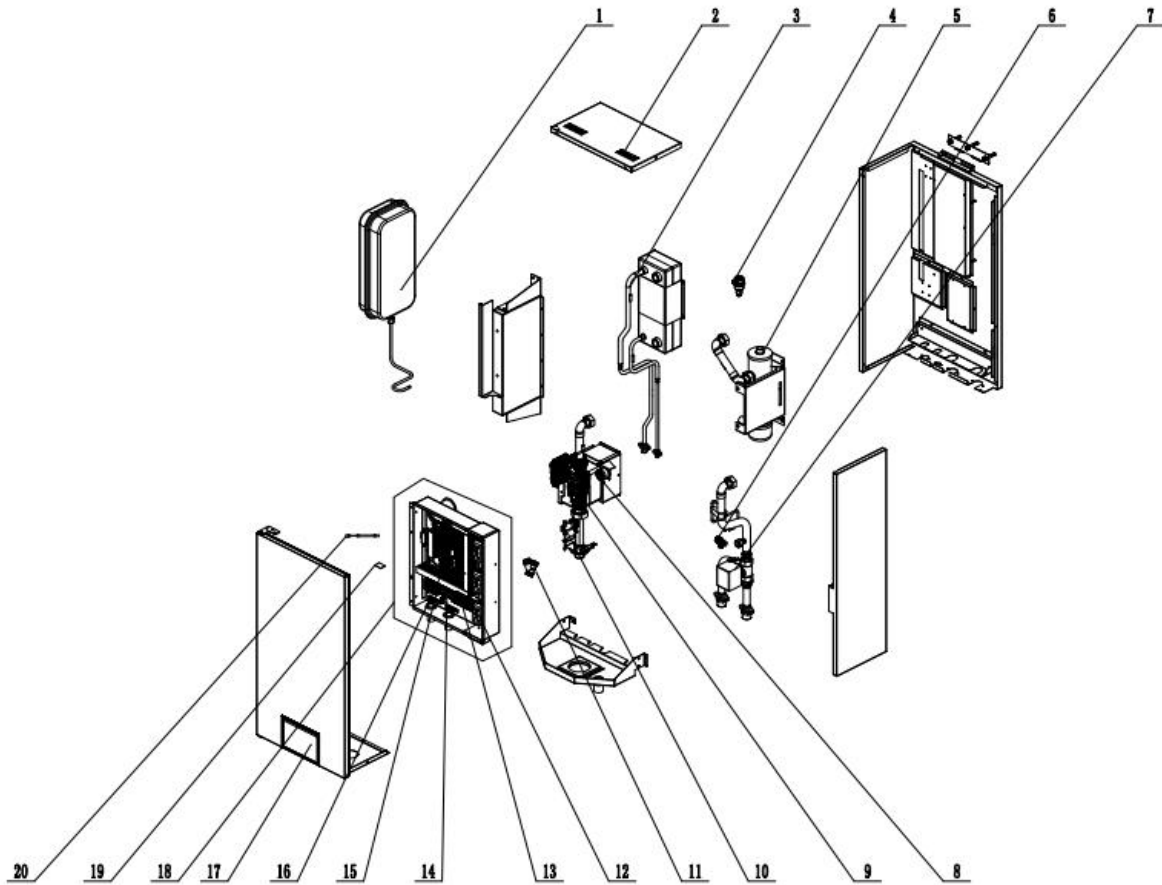

NO.	Part Description	qty	Part Code
1	Expansion Drum	1	07422800004
2	Handle	2	26904100016
3	Plate-type Heat Exchanger Sub-Assy	1	030166060111
4	Auto Air Outlet Valve	1	07108208
5	Electric Heater	1	320004060063
6	Relief Valve	1	07382814
7	Electric starter of water valve	1	4504800101
8	Water Pressure Gauge	1	49028009
9	Water Pump	1	812007060062
10	Steam current Switch	1	43001900000602
11	Strainer	1	035021000010
12	Bipolar AC Contactor	3	44010221
13	Terminal Board	1	422000000010
14	Terminal Board	1	422000000021
15	Terminal Board	1	4201005202
16	Main Board	1	300002060375
17	Display Board	1	300001060562
18	Electric Box Assy	1	100002066572
19	Jumper	1	4202021907
20	Sensor Sub-assy	1	390002060102

SMH-80ERB

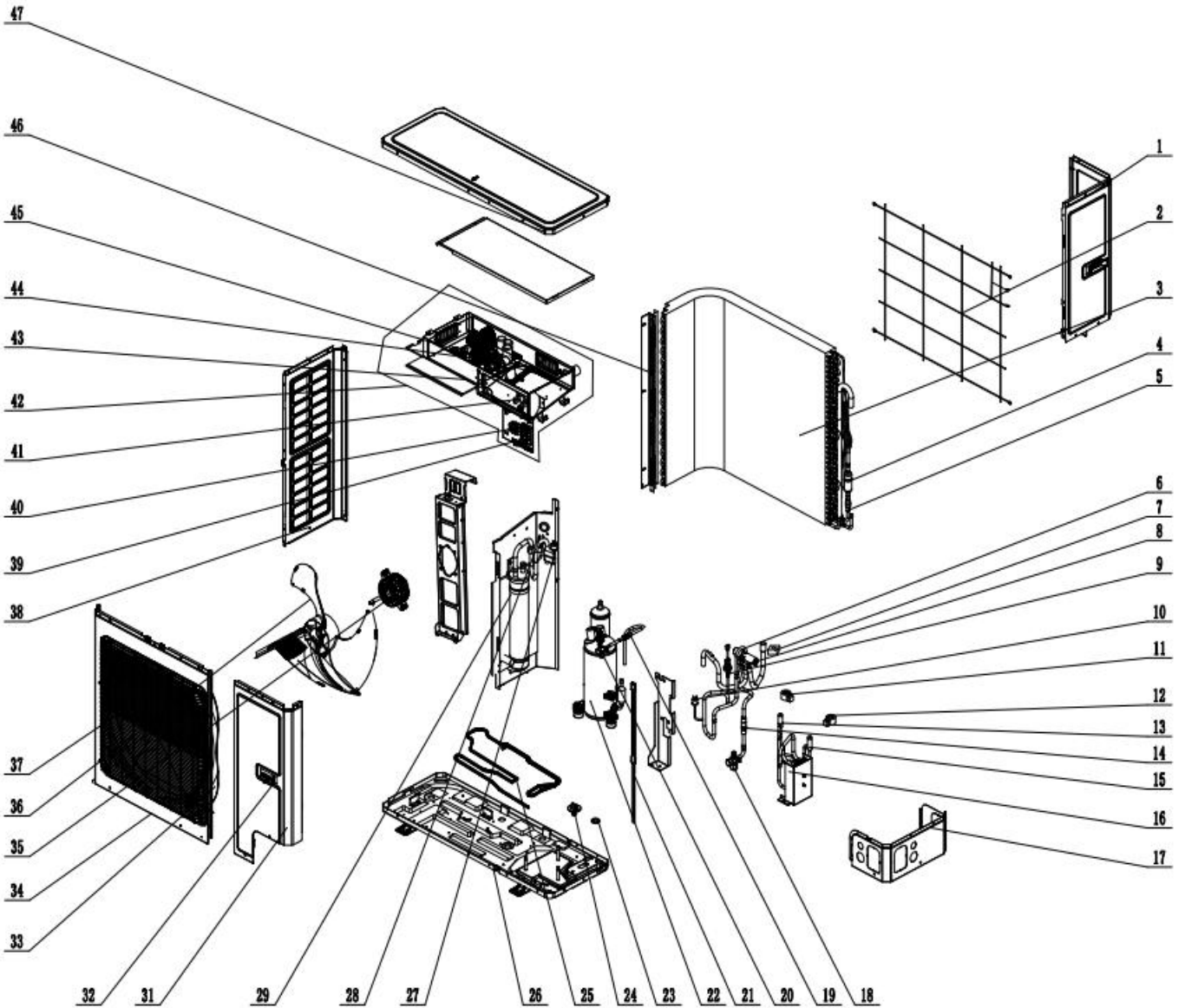

SMH-80ERB

NO.	Part Description	qty	Part Code
1	Rear Side Plate	1	01314100045P
2	Rear Grill	1	01600100004101
3	Condenser Assy	1	01122800090
4	Silencer	1	07245012
5	Strainer	1	0721212101
6	4-Way Valve Assy	1	030152060359
7	Magnet Coil	1	4300040029
8	4-way Valve	1	4300008201
9	Sensor (High Pressure)	1	322101032
10	Pressure Protect Switch	1	460200062
11	Electric Expand Valve Fitting	1	4304413208
12	Electric Expand Valve Fitting	1	4304413236
13	Electronic Expansion Valve	1	072009000001
14	Strainer	1	0721200102
15	Electronic Expansion Valve	1	43042800008
16	Plate-type Heat Exchanger	1	010007060013
17	Right Side Plate Sub-Assy	1	01314100109
18	Cut off Valve	1	07304100015
19	Filter	1	07224803
20	Cut off Valve	1	07130239
21	Electric Heater(Compressor)	1	7651873215
22	Compressor and Fittings	1	009001000265
23	Drainage hole Cap	3	06813401
24	Drainage Connector	1	06123401
25	Electrical Heater	1	765100049
26	Chassis	1	01284100101
27	Pressure Protect Switch	1	460200048
28	Pressure Protect Switch	1	460200046
29	Gas-liquid Separator	1	035027000024
30	Motor Support Sub-Assy	1	01804100309
31	Front Side Plate	1	01314100044P
32	Handle	2	26235253
33	Diversion Circle	1	10474100003
34	Cabinet Assy	1	01512800062
35	Brushless DC Motor	1	150104060013
36	Axial Flow Fan	1	1043410000801
37	Front Grill	1	01572800003
38	Left Side Plate	1	01314100043P
39	Communication Interface Board	1	300014060017
40	Terminal Board	1	42200000001501
41	Filter Board	1	300020000017
42	Electric Box Assy	1	100002066654
43	Radiator	1	430034000014
44	Main Board	1	300027060442
45	Main Board	1	300027060253
46	Supporting Strip(Condenser)	1	01894100053

SMH-100IRB

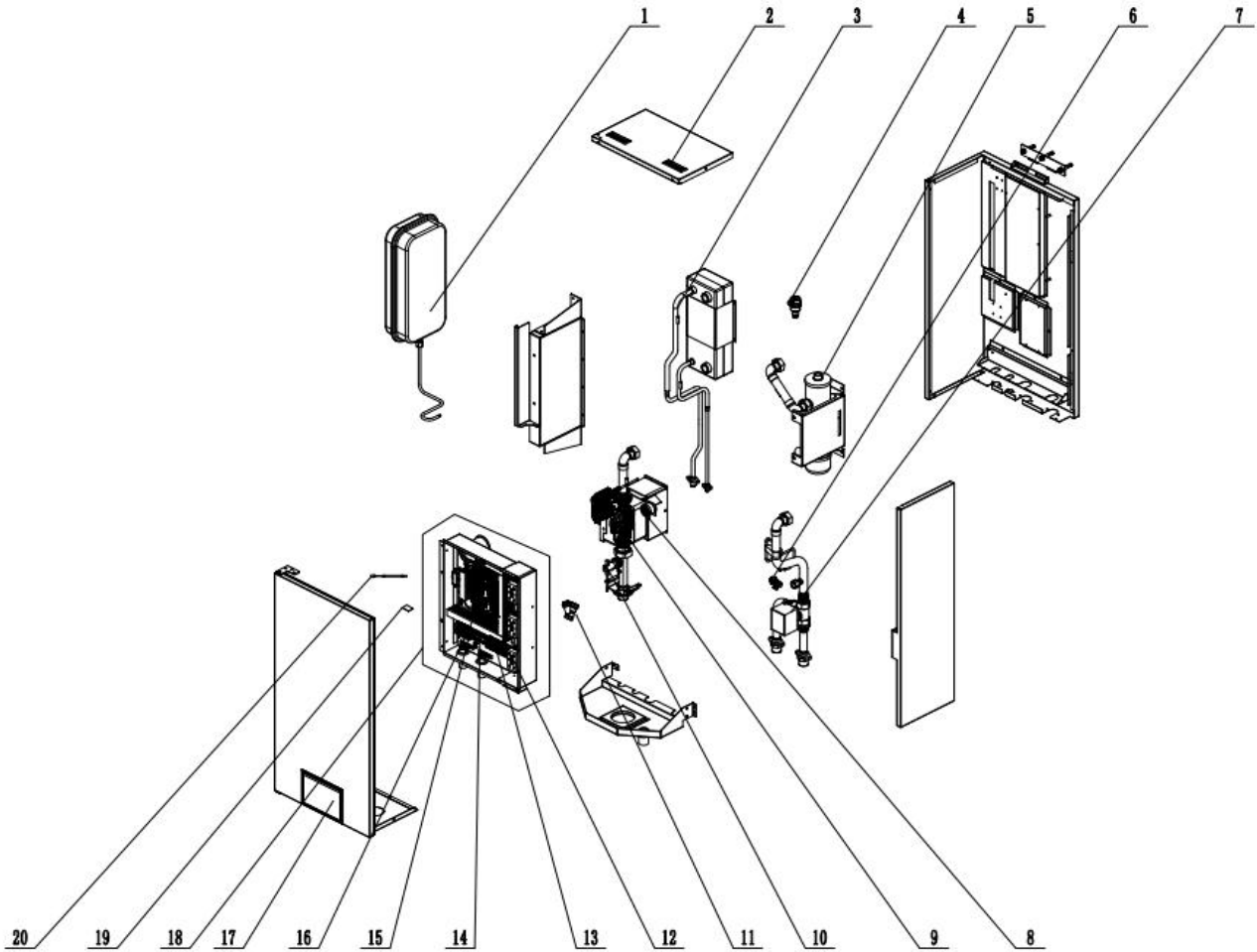

NO.	Part Description	qty	Part Code
1	Expansion Drum	1	07422800004
2	Handle	2	26904100016
3	Plate-type Heat Exchanger Sub-Assy	1	030166060111
4	Auto Air Outlet Valve	1	07108208
5	Electric Heater	1	320004060063
6	Relief Valve	1	07382814
7	Electric starter of water valve	1	4504800101
8	Water Pressure Gauge	1	49028009
9	Water Pump	1	812007060062
10	Steam current Switch	1	43001900000602
11	Strainer	1	035021000010
12	Bipolar AC Contactor	3	44010221
13	Terminal Board	1	422000000010
14	Terminal Board	1	422000000021
15	Terminal Board	1	4201005202
16	Main Board	1	300002060375
17	Display Board	1	300001060562
18	Electric Box Assy	1	100002066572
19	Jumper	1	4202021907
20	Sensor Sub-assy	1	390002060102

SMH-100ERB

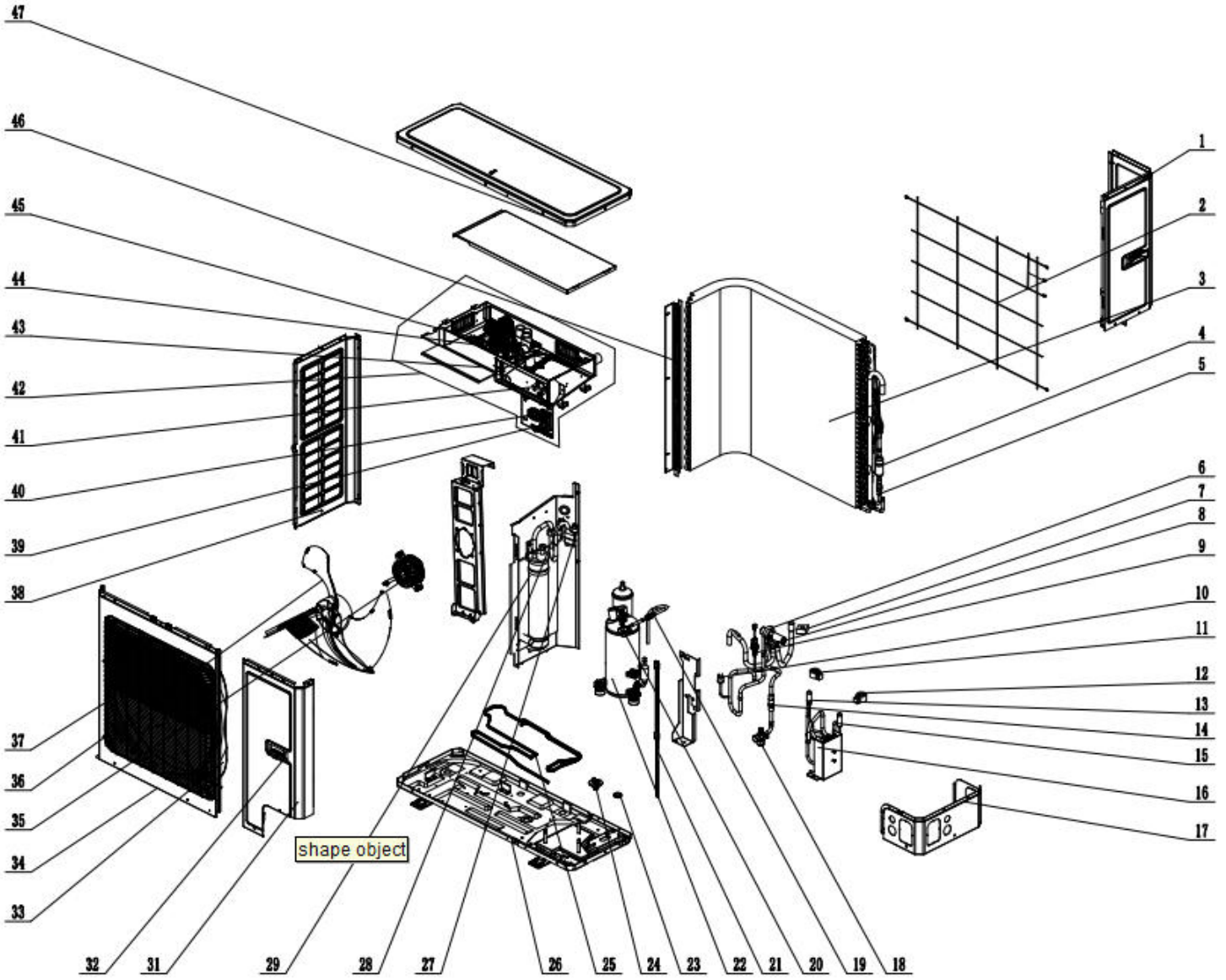

Engineering Data

SMH-100ERB

NO.	Part Description	qty	Part Code
1	Rear Side Plate	1	01314100045P
2	Rear Grill	1	01600100004101
3	Condenser Assy	1	01122800090
4	Silencer	1	07245012
5	Strainer	1	0721212101
6	4-Way Valve Assy	1	030152060359
7	Magnet Coil	1	4300040029
8	4-way Valve	1	4300008201
9	Sensor (High Pressure)	1	322101032
10	Pressure Protect Switch	1	460200062
11	Electric Expand Valve Fitting	1	4304413208
12	Electric Expand Valve Fitting	1	4304413236
13	Electronic Expansion Valve	1	072009000001
14	Strainer	1	0721200102
15	Electronic Expansion Valve	1	43042800008
16	Plate-type Heat Exchanger	1	010007060013
17	Right Side Plate Sub-Assy	1	01314100109
18	Cut off Valve	1	07304100015
19	Filter	1	07224803
20	Cut off Valve	1	07130239
21	Electric Heater(Compressor)	1	7651873215
22	Compressor and Fittings	1	009001000265
23	Drainage hole Cap	3	06813401
24	Drainage Connector	1	06123401
25	Electrical Heater	1	765100049
26	Chassis	1	000191060046
27	Pressure Protect Switch	1	460200048
28	Pressure Protect Switch	1	460200046
29	Gas-liquid Separator	1	035027000024
30	Motor Support Sub-Assy	1	01804100309
31	Front Side Plate	1	01314100044P
32	Handle	2	26235253
33	Diversion Circle	1	10474100003
34	Cabinet Assy	1	01512800062
35	Brushless DC Motor	1	150104060013
36	Axial Flow Fan	1	1043410000801
37	Front Grill	1	01572800003
38	Left Side Plate	1	01314100043P
39	Communication Interface Board	1	300014060017
40	Terminal Board	1	42200000001501
41	Filter Board	1	300020000017
42	Electric Box Assy	1	100002066654
43	Radiator	1	430034000014
44	Main Board	1	300027060442
45	Main Board	1	300027060253
46	Supporting Strip(Condenser)	1	01894100053
47	Coping	1	01264100027P

4 Supply Scope

S= Standard O= Optional F= Field Supplied

Name	Standard	Optional	Field Supplied
Owner's Manual for the Main Unit	√	/	/
Owner's Manual for the Control	√	/	/
2-way Valve	/	/	√
3-way Valve	√	/	/
Remote Temperature Sensor	√	/	/
Wired Controller	√	/	/
Communication Cable	√	/	/
Water Tank Temperature Sensor	√	/	/
Expansion Bolt	√	/	/
Other thermal	/	/	√
Optional Electric Heater	√	/	/

DESIGN & SELECTION

1 Installation Example

CASE 1: Connecting Under-floor Coil for Heating and Cooling

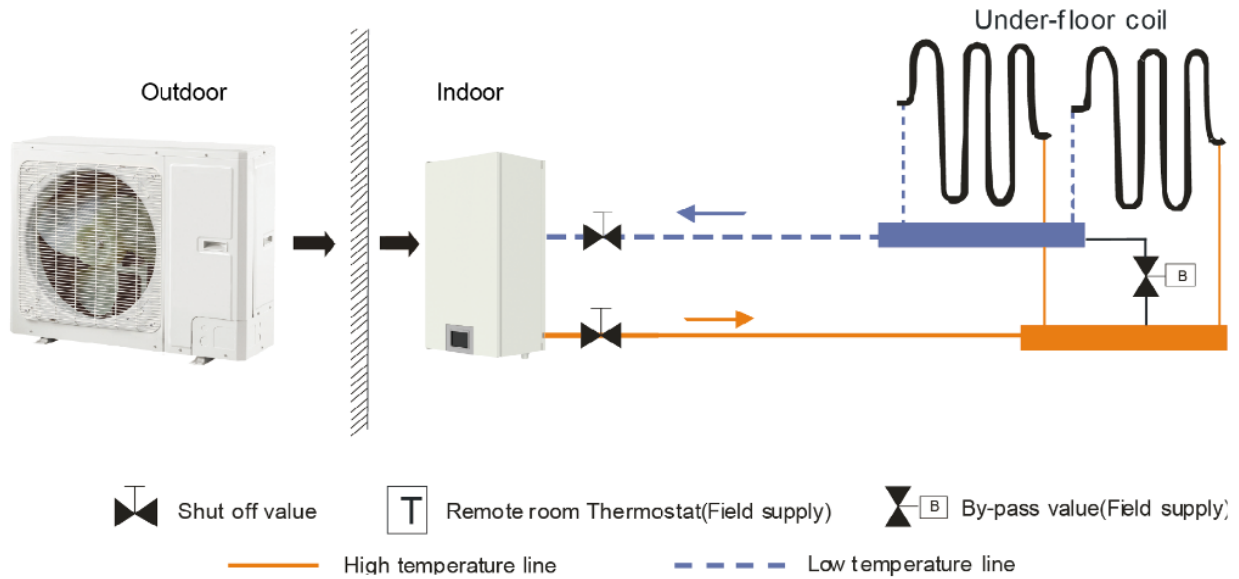

Notes:

- ① The two-way valve is very important to prevent dew condensation on the floor and radiator while cooling mode;
- ② Type of thermostat and specification should be complied with installation of this manual;
- ③ The bypass valve must be installed to secure enough water flow rate, and should be installed at the collector.

CASE 2: Connecting Sanitary Water Tank and under floor coil

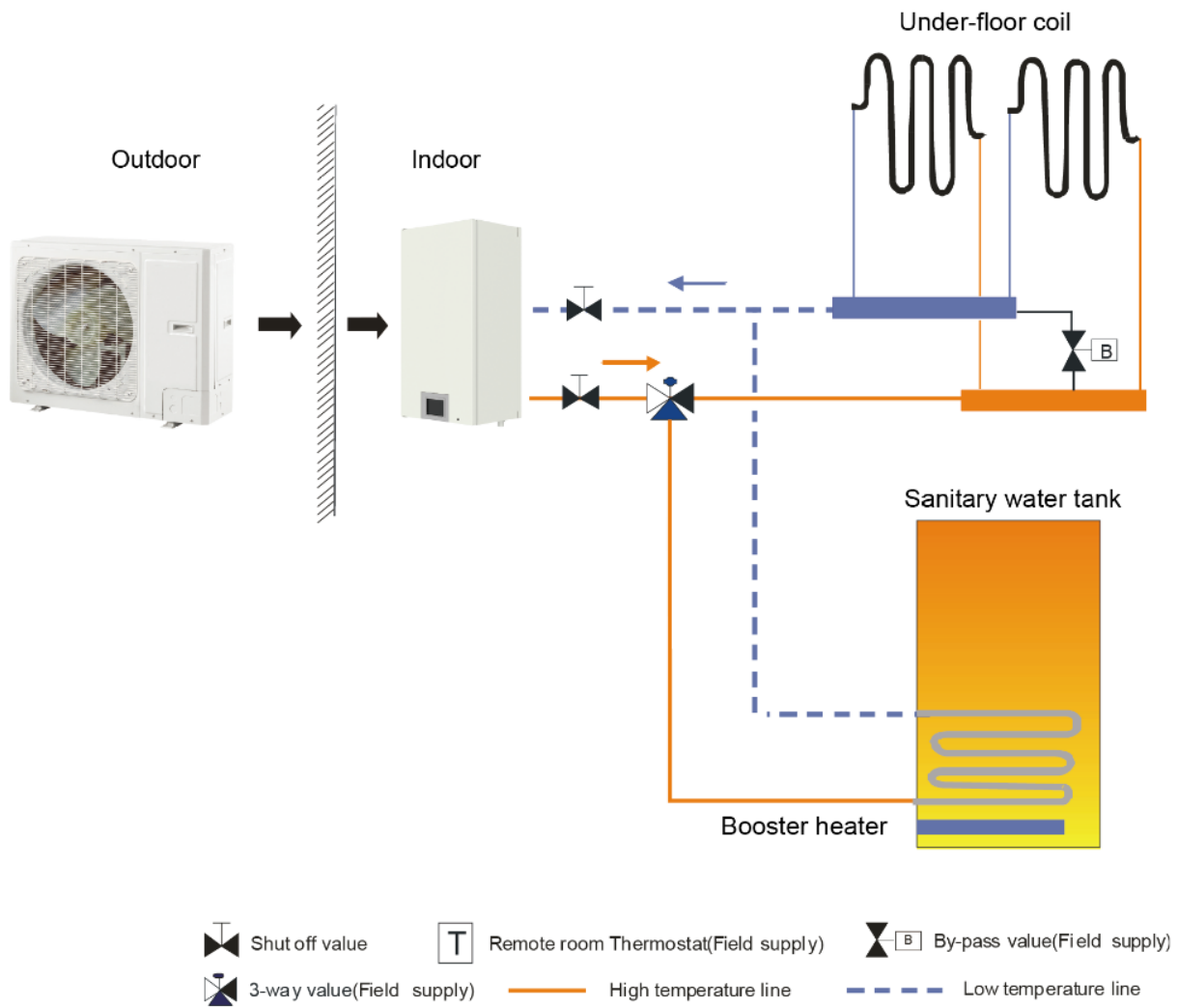

Notes:

- ① In this case, three-way valve should be installed and should be complied with installation of this manual;
- ② Sanitary water tank should be equipped with internal electric heater to secure enough heat energy in the very cold days;

CASE 3: Connecting Sanitary Water Tank, Under-floor Coil and FCU

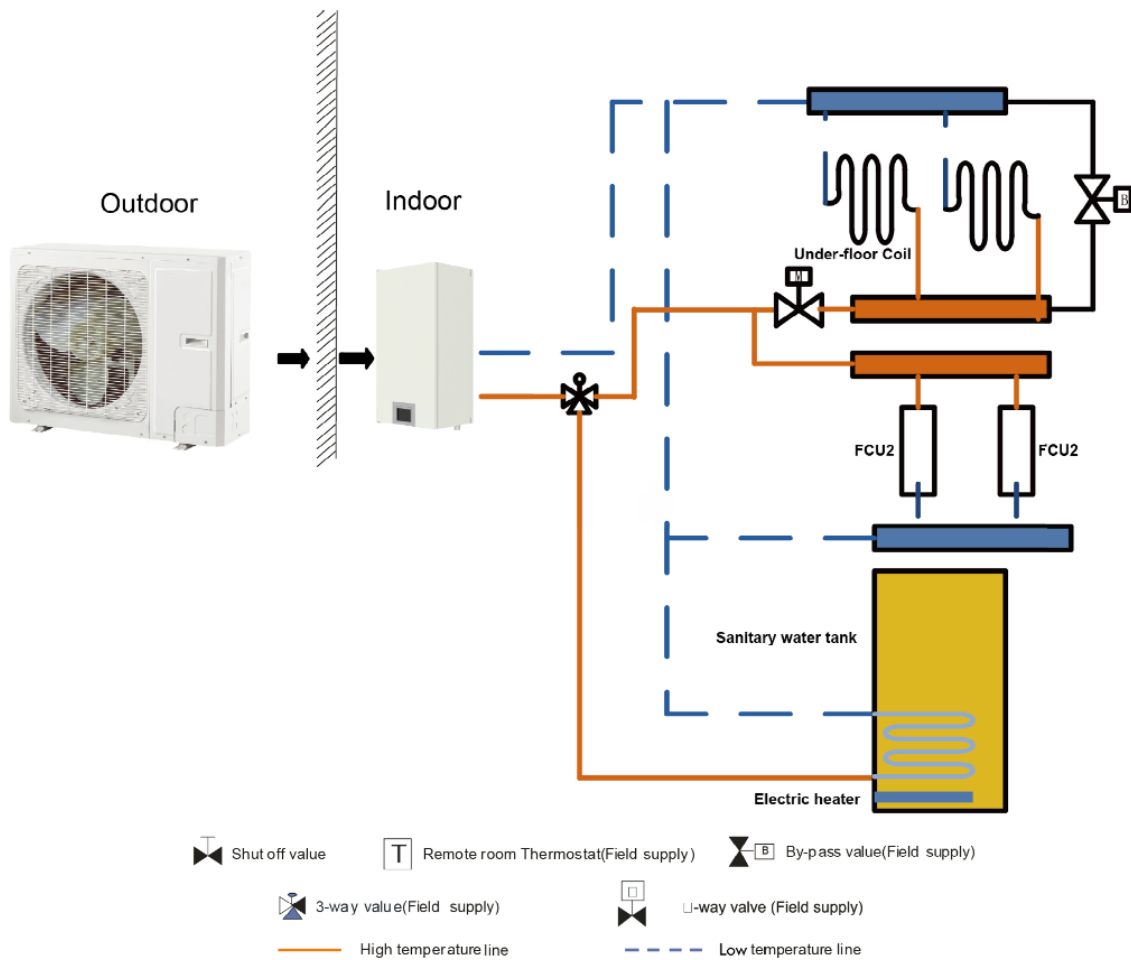

Notes

- ① The two-way valve is very important to prevent dew condensation on the floor and FCU while cooling mode
- ② In this case, three-way valve should be installed and should be complied with installation of this manual;
- ③ Sanitary water tank should be equipped with internal electric heater to secure enough heat energy in the very cold days.
- ④ (d) When the FCU and the underfloor coil are used at the same time, performance of the underfloor coil is satisfied firstly. When performance of the FCU is required, then “Floor config” should be set to “Without” .

2 Model Selection

2.1 Speculations of Power Supply

Model	Power Supply
	V,Ph,Hz
GSH-100IRB	230VAC,50Hz
GSH-80IRB	

2.2 Operation Conditions

Capacities and power inputs are based on the following conditions (floor heating /cooling)	
a. Cooling conditions	b. Heating conditions
Indoor Water Temp 23°C/18°C;	Indoor Water Temp 30°C/35°C;
Outdoor Air Temp 35°C DB/24°C WB	Outdoor Air Temp 7°C DB/6°C WB
Capacities and power inputs are based on the following conditions (FCU or radiator)	
a. Cooling conditions	b. Heating conditions
Indoor Water Temp 12°C/7°C;	Indoor Water Temp 40°C/45°C;
Outdoor Air Temp 35°C DB/24°C WB	Outdoor Air Temp 7°C DB/6°C WB

2.3 Flowchart of Model Selection

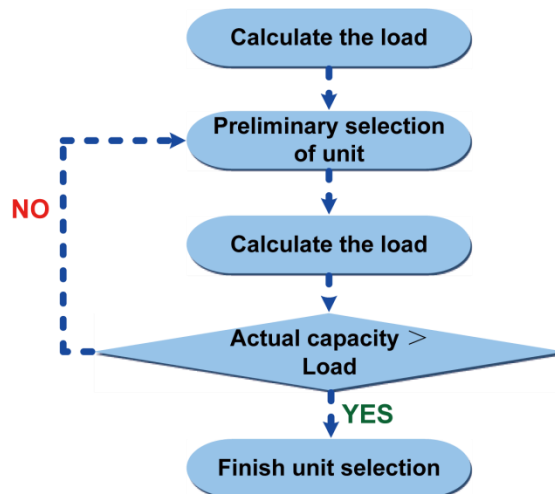

2.4 Design Principle

- ◆ Cooling: capacity of the unit \geq cooling load of the air conditioning
- ◆ Heating: capacity of the unit \geq max{ heating load, floor heating load, water heating load}
- ◆ Water Tank: it should be selected based on the sanitary outfit or quantity of users. Each unit can accommodate only one water tank.

3 Selection of the Underfloor Coils

3.1 Calculation of Unit Load for Floor Heating

Empirical Values of Floor Heating Load Per Square Meter

House W/m ²	
Dining Room	100~120
Mater Room	100~110
Guest Room	110~130
Study Room	90~110
Villa W/m ²	
Dining Room	110~140
Mater Room	100~120
Guest Room	100~130
Study Room	100~120

Notes:

- 1 Villas whose load is generally larger than the houses should take the value between the middle and the maximum empirical values listed above.
- 2 The top layer whose load is generally larger than the middle or bottom layer should take the maximum empirical value.
- 3 The guest room whose load is generally much large should take the value between the intermediate and the maximum empirical values listed above.
- 4 For those whose external walls or glass areas are large, it is recommended to take the load calculation.
- 5 The heating load for the bathroom is generally 500W/room.

3.2 Selection of Tube Spacing of the Underfloor Coils

Tube spacing of the underfloor coils which will directly affect heat dissipation of the floor depends on the tube material, indoor design temperature, supply water temperature and floor material.

Heat Dissipation of Commonly Used Coils

(Tube material: PE-X, Indoor temperature:18°C, Average water temperature:45°C)

Floor Material	Thermal Resistance m ² ·K/W	Tube Spacing mm	Heat Dissipation W/m ²	Tube Spacing mm	Heat Dissipation W/m ²
Stone	0.02	200	147.0	150	159.8
Wood	0.075	200	111.2	150	117.8

The dissipated heat of the floor coil is larger than the load for the floor heating system; however the deviation cannot be larger than 10%.

3.3 Selection of Loop Quantity of Coils for Each Room

3.3.1 Type of Underfloor Coils

When selecting underfloor coils, we should consider both their comfortability and heating capacity. The most commonly used coils are as shown below.

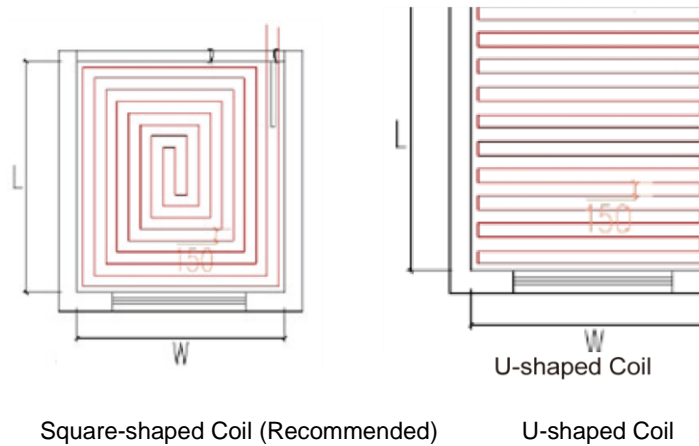

Length of coils is calculated as below:

Square-shaped coil: $=L \cdot W / \text{tube spacing} = \text{area} / \text{tube spacing}$

U-shaped coil: $=L - 1 + L \cdot W / \text{tube spacing} = L - 1 + \text{area} / \text{tube spacing}$

The reason why the square-shaped coils are recommended is because they can keep even temperature distribution. Special demand can be met by adjusting the tube spacing.

Distance from the room to the water trap/collector should be estimated according to the actual conditions of the project and generally should not exceed 30m.

3.3.2 Selection of Loop Quantity for Each Room

- ◆ Length of a single loop should not exceed 100m. If so, it should be divided into multiple loops.
- ◆ Area of a single loop = tube length \times tube spacing = $100\text{m} \times 150\text{mm} = 15\text{m}^2$

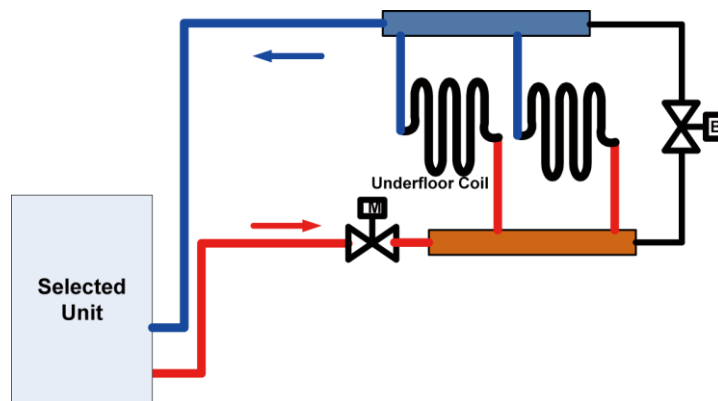

Length of underfloor coils is recommended to be within 100m and length of each branch should be kept the same to the most extent.

4 Quantity and Location of the Water Traps and Collectors

The water trap (collector) is a kind of device for distributing water for the water supply and return tubes.

4.1 Design Requirements on Loop Quantity for Circulation Water

- (1) One water trap (collector) is allowed for at most eight loops. When quantity of loops exceeds 12, then two traps (collectors) should be used, or it will cause uneven water distribution.
- (2) The maximum flow rate of the water trap (collector) should be less than 0.8m/s.
- (3) The inlet and outlet of each loop should be connected to the water trap (collector) and the inner diameter of the water trap (collector) should be or larger than that of the main water supply/return tube.

Calculation of loop quantity for circulation water can be done as per the formula below:

$$N=A/A1$$

N—loop quantity

A— total floor heating area (unit: m²)

A1— floor heating area per single loop (unit: m²)

Example for how to calculating the floor heating area per single loop: when the tube length is 120m, and tube spacing is 200mm, then the floor heating area per single loop is 120x0.2=24m².

- (4) One trap (collector) cannot be used for different floors, or it would cause uneven water distribution.

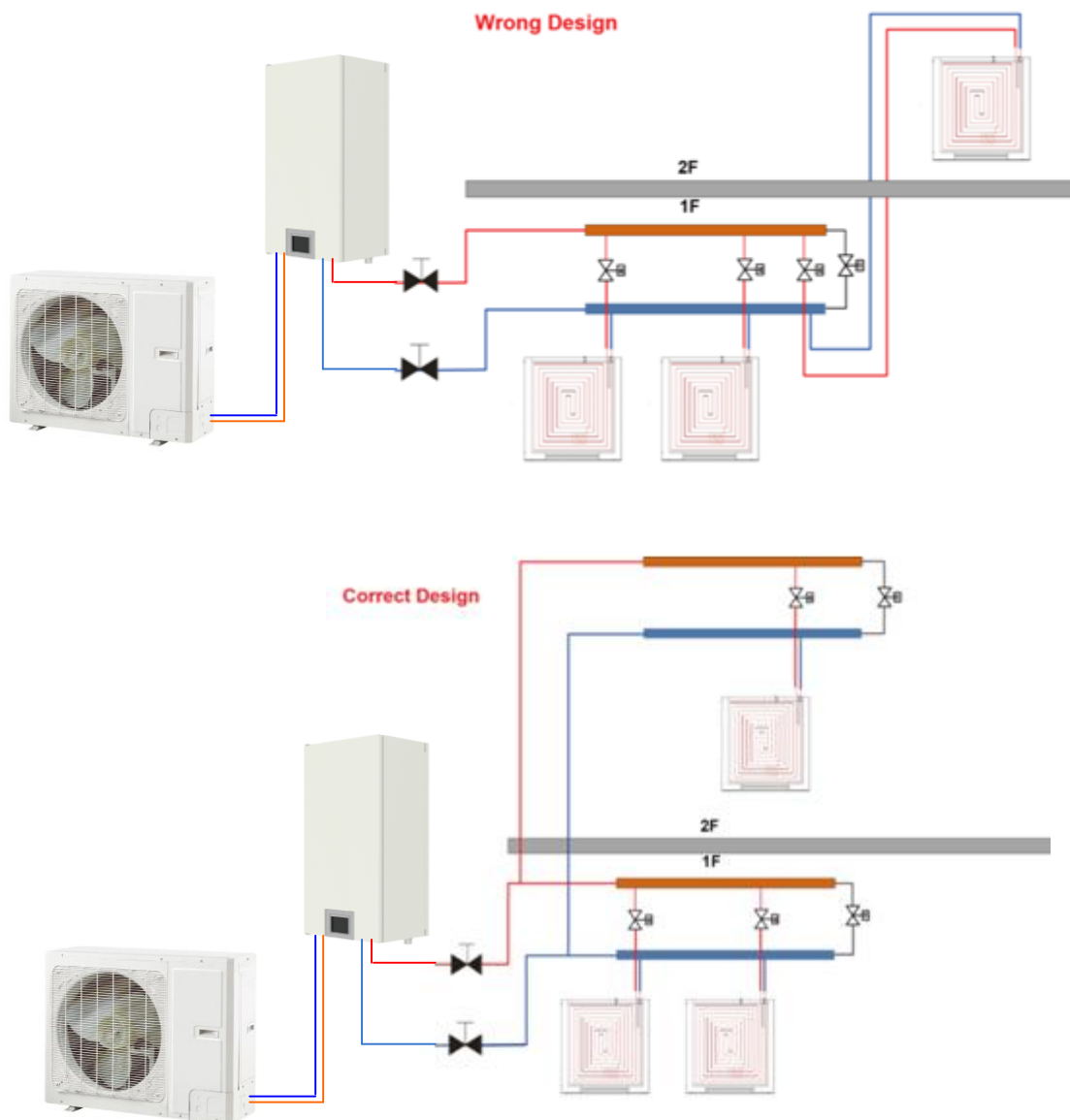

- (5) Distance between the unit and the water trap (collector) should be within 15m. If the distance exceeds 20m, then it is required to calculate the hydraulic power.

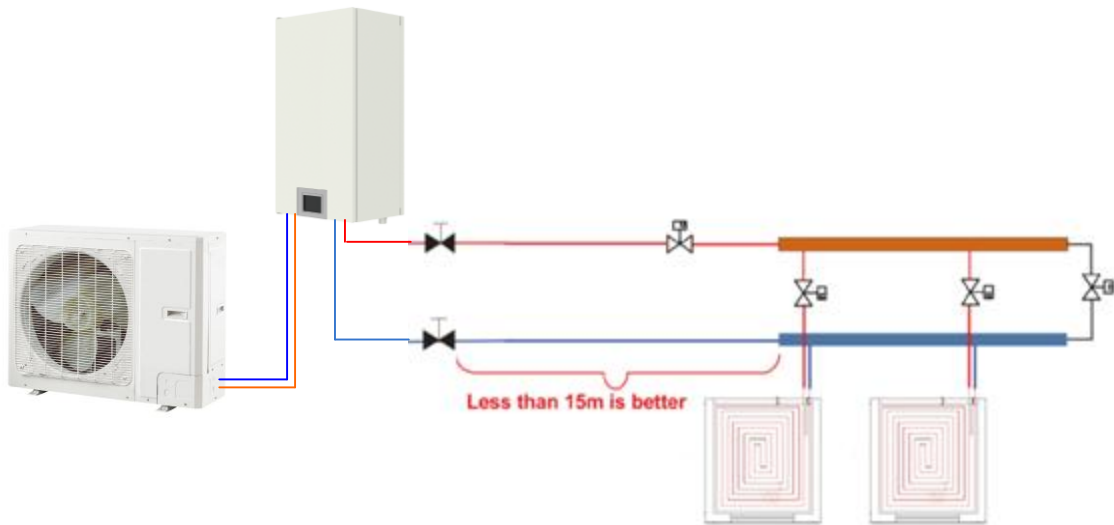

4.2 Requirements on Installation of the Water Trap (Collector)

- (1) The water trap (collector) should be installed on the wall or inside the special box. For housing constructions, it is generally installed in the kitchen.
- (2) The valve for the water trap (collector) should be installed horizontally and keep a distance of at least 300mm to the ground.
- (3) The water supply valve should be installed upstream of the water trap (collector) and the return valve should be installed downstream of the water trap (collector).
- (4) A filter is required upstream of the water trap (collector).

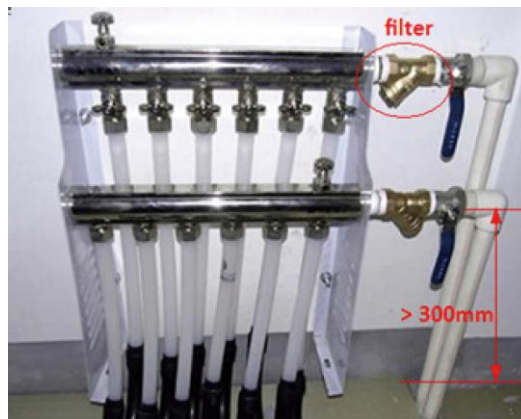

5 Section of FCU

5.1 FCU Type Selection

The air-water fan coil unit is optional for Versati units.

5.2 Matching of Capacity



Load of the FCU is better to be between 70%~120% of the Versati unit.

Notes:

- ① When load of the FCU is too small, the unit would start/stop frequently, which is adverse for oil

return.

- ② When load of the FCU is too large, the unit would always run under high frequency, which is unhelpful for energy conservation.

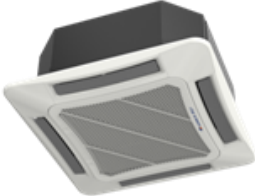
Type	Air Volume (m ³ /h)	Cooling Capacity (kW)	Heating Capacity (kW)	Static Pressure (Pa)	Appearance
Wall mounted type	166~1020	2.1~5.4	3.15~8.5	—	
Concealed ceiling type	213~2380	1.85~12.8	3.1~21	12, 30	
Floor ceiling type	213~2040	1.9~10.8	2.8~16.2	—	
Cassette type	480~1700	4.5~9	6.8~13.7	—	

6 Selection of the Water Tank

6.2 Volume Selection of the Water Tank

6.2.1 Selection Based on Water Consumption Per Capita

Building Type	Unit	Daily Water Consumption (L)	Water Temperature (°C)
House	Per person, Per day	40~80	60
Villa	Per person, Per day	70~110	60

6.2.2 Selection Based on Sanitary Utensils

Utensil Type	Daily Water Consumption (L)	Water Temperature (°C)
Bathtub, Sprinkler system (with shower)	150	40
Bathtub, Sprinkler system (without shower)	125	40
Shower	70~100	37~40
Wash Basin	3	30

6.2.3 Selection of the Water Tank

Selection of the water tank should consider the flow rate of the shower head, duration of use per person and daily water consumption.

$$\text{Volume of the Water Tank} = \frac{t(\text{design temperature}) - t(\text{entering cold water temperature})}{t(\text{water tank temperature set point}) - t(\text{entering cold water temperature})} \cdot \text{consumption}$$

$$= \alpha \cdot \text{consumption}$$

t (design temperature): generally it is 60°C ;

t (entering cold water temperature): it differs for different regions;

t (water tank temperature set point): it is the target heating temperature of the water tank.

α: correction factor

Empirical Values for Volume Correction of the Water Tank

Duration of Use (min/Person) Flow Rate of the Shower Head (L/min)	10	15	20	25	30	40
	4	0.48	0.71	0.94	1.18	1.42
6	0.71	1.06	1.42	1.77	2.12	2.83
8	0.95	1.42	1.89	2.36	2.83	3.77
10	1.18	1.77	2.36	2.95	3.54	4.72
15	1.76	2.65	3.54	4.42	5.31	7.08

Empirical values are worked out under conditions of 80L consumption (per day per person), 8L/min flow rate of the shower head, and 10 minutes use duration per person.

7 Examples for Model Selection

7.1 General Introduction to the Example Project

For a two-floor house, there is a master room and a both room for each floor and both of them require floor heating. Other rooms use the heat pump for heating in winter. The master room covers 28m² and the both room covers 12m².

7.2 Heat Load Calculation

7.2.1 Load Calculation of a Single Floor

Room	Area	Heat Index (W/m ²)	Heat Load (W)
Master Room	28	82	2296
Bathroom	12	72	900
Total Load	2296+900=3196W		

7.2.2 Arrangement Design of the Underfloor System for A Single Floor

Assumed conditions: the floor is cement or ceramics, the normal external diameter of the heating pipe is 20mm, thickness of the stuffer is 50mm, thickness of PS foam insulation is 20mm, supply water temperature is 45°C, return water temperature is 35°C, indoor design temperature is 20°C.

$$\text{Average Temperature of the Heating Pipe}=(45+35)/2=40^{\circ}\text{C}$$

7.2.3 Arrangement Design of the Underfloor System for the Bath Room

Heat load of the bath room is 900W, heat dissipation per unit area is 75W/m², tube spacing of the heat pipe is 30mm, and heat loss is 25.4 W/m², then the total heat loss is:

$$25.4 \times 12 = 304.8\text{W}$$

Based on the heat load listed in the table above, the heating load for the bathroom is:

$$900 + 304.8 = 1204.8\text{W}$$

According to the formula $Q = CpG\Delta T$, the flow rate of the heating pipe for the bathroom is:

$$G = \frac{Q}{Cp\Delta T} = \frac{1.2048\text{kJ}/(1/3600\text{h})}{4.186\text{kJ}/(\text{kg}\cdot^{\circ}\text{C}) \times 1000\text{kg}/\text{m}^3 \times (45-35)^{\circ}\text{C}} = 0.104\text{m}^3/\text{h}$$

If the outer diameter of the heating pipe is 20mm and thickness is 2mm, then the minimum flow for the heating pipe is:

$$G = \pi/4 D^2 v = 3.14/4 * (20-2*2)^2 * 10^{-6} * 0.25 * 3600 = (0.18\text{m}^3)/\text{h}$$

It can be see that the arranged piping system for the bathroom does not meet the technical requirement and must be used in common for the master room.

7.2.4 Arrangement Design of the Underfloor System for the Master and Bath Rooms

According to the calculation results, the total heat load for the master and bath rooms is 3196W, heat dissipation per unit area is 82W/m², tube spacing of the heating pipe is 300mm, and heat loss is 25.4 W/m², then the total heat loss is:

$$3196 + 1016 = 4212\text{W}$$

According to the formula $Q = CpG\Delta T$, the flow rate is

$$G = \frac{Q}{Cp\Delta T} = \frac{4.212\text{kJ}/(1/3600\text{h})}{4.186\text{kJ}/(\text{kg}\cdot^{\circ}\text{C}) * 1000\text{kg}/\text{m}^3 * (45-35)^{\circ}\text{C}} = 0.3622\text{m}^3/\text{h} > 0.18\text{m}^3/\text{h}$$

Loop quantity is 0.3622/0.18=2.012 and the round-off number is 2.

7.2.5 Check

A. Check for the flow rate

$$\frac{0.3622/2}{3.14*0.008^2*3600} = 0.2503\text{m/s}$$

Floor rate of each loop is within 0.25~0.5m/s and the system can run stably.

B. Check for the tube length

When the average tube spacing is 30mm, the required length of the heating pipe per square meter is 3.5m, length of total coils is $3.5 \times 40 = 140$ and length for each loop is $140/2 = 70$.

It can be seen that the length for each loop is less than 120m and there it meets the design requirement.

C. Check for the ground average temperature

$$t_p = t_n + 9.82 \times (q_x / 100) \cdot 0.969 = 20 + 9.82 \times (82 / 100) \cdot 0.969 = 28^\circ\text{C}$$

Upper Limits and Average Floor Temperature

Average Floor Temperature		
Area	Average Temperature	Maximum Temperature
Long-term Dwelling Area	24~26	28
Short-term Dwelling Area	28~30	32
Nobody Area	35~40	42

7.3 Model Selection

Heat demand for a single layer: 3196W

Heat loss for a single layer: 1016W

Total heat load for a single layer: 4212W

Total heat load of the building: 8424W

Capacity of the main unit should be larger than 8424W, so we can select: **GSH-100IRB**

UNIT CONTROL

1 Integral Control Concept

1.1 Control Principle Diagram

◆ Control Diagram

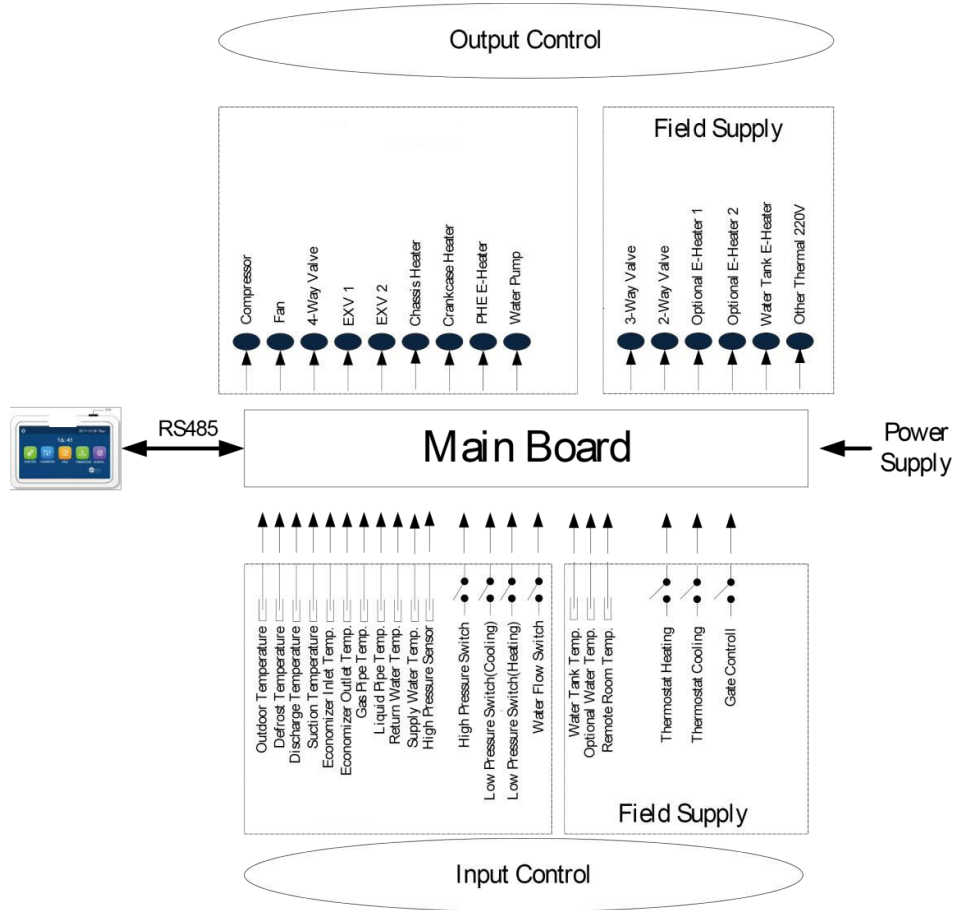

◆ complete electric connection diagram

1. The outdoor temperature is detected by the sensor installed at fins of the finned heat exchanger, which is mainly used to control the initialization steps of the fan and the electrostatic expansion valve and also limit the maximum running frequency of the compressor. When this sensor fails, the main board will detect it and deliver this error message to the controller and then the unit will fail to start up or shut down.

2. The defroste temperature is detected by the sensor installed at the defrosting pipes of the finned heat exchanger, which is mainly used to control defrosting. When this sensor fails at the heating or water heating mode, the compressor will stop and this error will be displayed at the controller. When it fails at the cooling mode, the compressor continues to run but this error will be displayed at the controller.

3. The discharge temperature is detected by the sensor installed at the discharge pipe of the compressor, which is mainly used for high discharge temperature protection. When this sensor fails, this error will be displayed at the controller, all loads except the water pump of the solar system and the electric heater of the water tank will stop. Then, the main unit will resume normal running when this error is eliminated.

4. The suction temperature is detected by the sensor installed at the suction pipe of the compressor, which is mainly used to control superheating degree. When this sensor fails, this error will be displayed at the controller, all loads except the water pump of the solar system and the electric heater of the water tank will stop. Then, the main unit will resume normal running when this error is eliminated.

5. The temperature sensor at the economizer is used to detect the temperature of the economizer after throttling via the electrostatic expansion 2. Under the Heating or Hot Water mode, this sensor and that at the economizer outlet both are used to control the opening angle of the electrostatic expansion valve 2. Under the Cooling mode, the electrostatic expansion valve 2 is fully closed.

6. The temperature sensor at the economizer outlet is used to detect the temperature of the outlet of the economizer. Under the Heating or Hot Water mode, this sensor and that at the economiser inlet both are used to control the opening angle of the electrostatic expansion valve 2. Under the Cooling mode, the electrostatic expansion valve 2 is fully closed.

7. The high pressure is detected by the sensor installed at the discharge pipe of the compressor, the low pressure is detected by the sensor installed at the suction pipe of the compressor, and the enthalpy-adding pressure is detected by the sensor installed at the enthalpy-adding pipe. The first one is mainly used for high pressure protection, the second one is mainly used to control defrosting, freeze protection and superheating degree, and all of three are used to together to control the intermediate pressure ratio of the compressor. When any of these sensors fails, it will be displayed at the controller, all loads except the water pump of the solar system and the electric heater of the water tank will stop. Among them, the water pump will stop 120 seconds later than the compressor. Then, the main unit will resume normal running when this error is eliminated.

Component	Range
High pressure sensor	4.5/3.8MPa (absolute)
Low pressure switch (cooling)	0.45/0.55MPa (absolute)
Low pressure switch (heating)	0.1/0.2 MPa (absolute)

8. The return water temperature of the plate heat exchanger is detected by the sensor installed at the inlet pipe of the plate heat exchanger, which is mainly used for freeze protection. When this sensor fails, this error will be displayed at the controller but the unit will resume normal operation.

9. The supply water temperature of the plate heat exchanger is detected by the sensor installed at the outlet pipe of the plate heat exchanger, which is mainly used for freeze protection at the water side.

When this sensor fails, this error will be displayed at the controller and the unit will continue to operate.

10. The optional water temperature is detected by the sensor installed at the outlet pipe of the optional E-heater, which is mainly used to control the supply water temperature. When this sensor fails, this error will be displayed at the controller, all loads except the electric heater of the water tank will stop (the 2-way electric and 3-way electric valve will be closed).

11. The temperature sensor for the vapor line is used to detect the temperature of the vapor refrigerant line. Under the Cooling mode, it and that for the liquid line together are used to control the opening angle of the electrostatic expansion valve 1.

12. The temperature sensor for the liquid line is used to detect the temperature of the liquid refrigerant line. Under the Cooling mode, it and that for the vapor line together are used to control the opening angle of the electrostatic expansion valve 1.

13. The hi-pressure switch is used to judge the system pressure. When the pressure is too high, this switch will disconnect and the unit will shut down.

14. The flow switch of the main unit is mainly used to judge the water flow. When the flow rate is too low, this switch will be disconnected; all loads except the water tank heater and the water pump of the solar system will stop. This error will be displayed at the controller and will be unrecoverable. The unit can restart only when it is repowered on and this error does not be displayed again.

Items from 1~14 listed above are control parameters input by the main unit.

15. The water tank temperature is detected by sensors immersed inside the water tank. These sensors can be divided into two groups. Group 1 is used to control the water tank temperature and group 2 is used to display the water tank temperature. When group 1 fails at the heating mode, this error will be displayed at the controller, and all loads except the water pump of the main unit will stop. When group 2 fails, this error also will be displayed at the controller but the unit continues normal operation.

16. The leaving and entering water temperature of the solar panel and also the solar panel temperature are detected by sensors installed at the inlet pipe, outlet pipe and solar panel of the solar system respectively. These sensors are mainly used to control the water pump of the hot water of the solar system. When the entering water temperature sensor fails, this error will be displayed at the controller and the unit continues normal operation. When other two sensors fail, this error also will be displayed at the controller and the water pump of the solar system will stop.

17. The remote room temperature is detected by the sensor installed at the room, which is mainly used to control the input capacity of the compressor through room temperature setting. When the main unit is controlled through the room temperature and this sensor fails, all loads except the water pump of the solar system and the electric heater of the water tank will stop. However, when the main unit is controlled through the leaving water temperature, if this sensor fails, this error will be displayed but the main unit will resume normal operation.

18. Only when the control function of the thermostat has been activated through the wired controller, then the thermostat can switch run modes among cooling, heating and shutdown, otherwise, the unit will run as per the run mode set by the wired controller.

19. The gate control function can be set to be "On" or "Off" at the function setting page of the wired controller. When this function has been activated and it is detected that the gate control card has been drawn out, the unit will shut down and will tell any key operation of the controller is invalid. Then, if it is detected that the gate control card has been inserted in, the unit will resume normal operation.

20. The flow switch of the solar system is mainly used to judge the water flow. When the flow rate is too low, the flow switch will disconnect and immediately the water pump of the solar system will stop. This error will be displayed at the controller and is unrecoverable. When this error is cleared, upon power on again, the unit will restart.

Items 15~ 20 are control parameters input by the filed installed equipment.

1.2 Control Flowchart

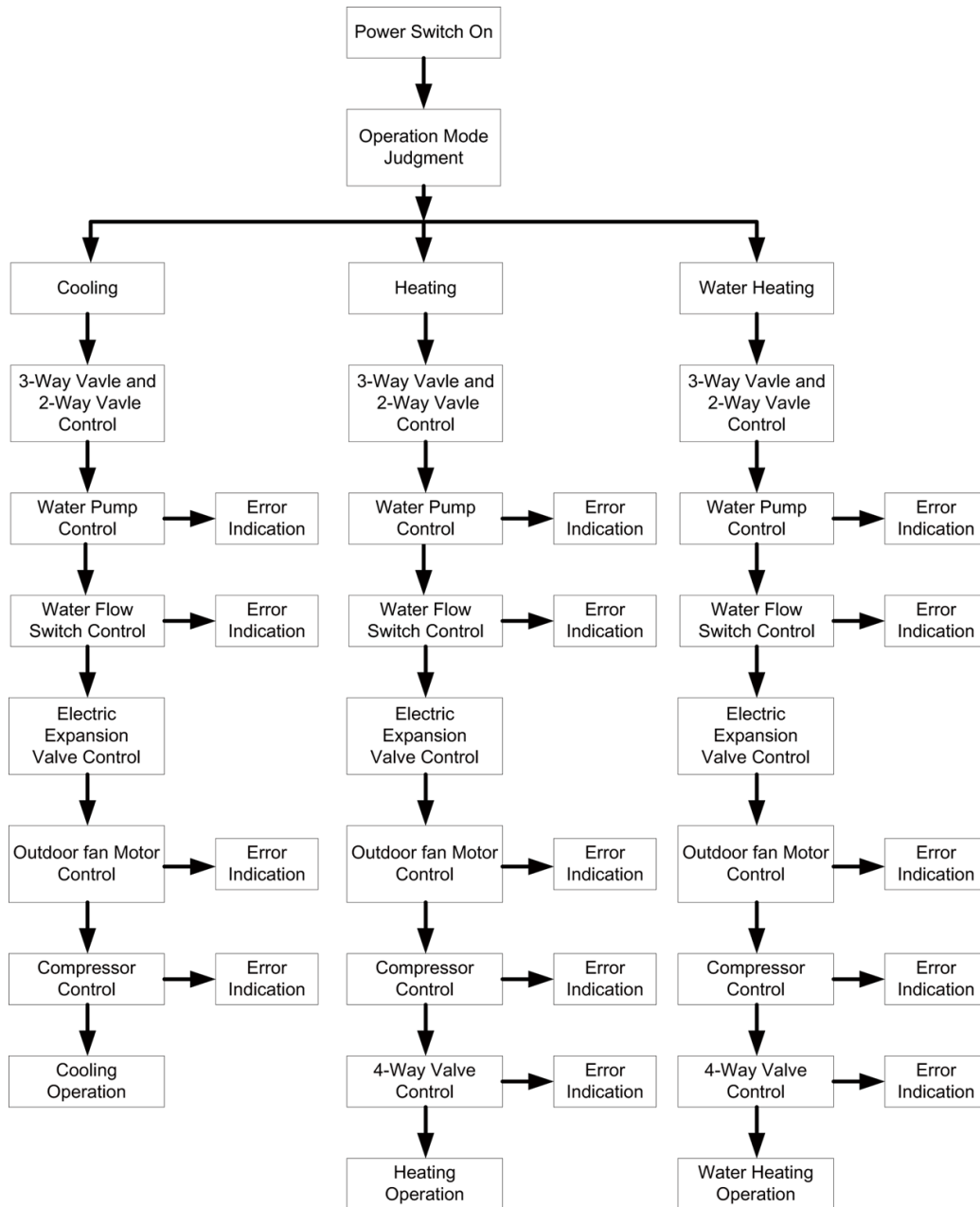

2 Main Control Logics

2.1 Cooling

2.1.1 Control to the Compressor

When the unit is controlled by the leaving water temperature, the operating frequency of the compressor will be adjusted by the temperature difference in the way that it increases as the temperature difference goes up and it decreases as the temperature difference goes down. (Temperature difference= actual leaving water temperature-leaving water temperature set point).

2.1.2 Freeze Protection

When it is detected that the leaving water temperature of the plate heat exchanger is lower than the

freeze protection temperature, the compressor will drop its operating frequency until it reaches the minimum operating frequency. Then if it is still detected that the leaving water temperature is lower than the freeze protection temperature, the main unit will stop as per the shutdown frequency but the water pump keeps normal operation.

When it is detected that the leaving water temperature of the plate heat exchanger is equal to or larger than the freeze protection withdrawing temperature, freeze protection will exit. At this point, once the compressor has stopped for three minutes and conditions for startup have been satisfied, the compressor will run for cooling.

2.2 Heating

2.2.1 Control to the Compressor

When the unit is controlled by the leaving water temperature, the operating frequency of the compressor will be adjusted by the temperature difference in the way that it increases as the temperature difference goes up and it decreases as the temperature difference goes down. When the compressor reaches the minimum frequency but the temperature frequency is still quite large, the unit will shut down (temperature difference= actual leaving water temperature-leaving water temperature set point).

2.2.2 Over-temperature Protection

When the compressor is running and it is detected that the leaving water temperature of the auxiliary electric heater is higher than the over-temperature protection temperature, the compressor will lower its frequency to the minimal. Then if it is still detected that the leaving water temperature of the auxiliary electric heater is higher than the over-temperature protection temperature, all loads except the water pump of the main unit and the 4-way valve will stop. Over-temperature protection will exit until the leaving water temperature of the auxiliary electric heater is lower than the over-temperature withdrawing temperature. After that, the unit will resume normal operation.

2.2.3 Control to the Optional Electric Heater

When the Optional electric heater is deactivated through the wired controller, it will never come into operation. When it is activated, it will run based on the outdoor temperature.

Note: If electric heating is directly connected to the unit control, the maximum power should not exceed 500W

2.3 Water Heating

Water heating can be achieved by either the solar system or the main unit (heat pump).

2.3.1 Water Heating by the Main Unit

1) When the outdoor temperature is out of the operation range, the compressor will not start, and water heating will be done by the water tank heater.

2) When the outdoor temperature is within the operation range, water heating will be done by the main unit. The output frequency of the compressor will be adjusted by the difference between the water tank temperature set point and the actual water tank temperature.

3) Control to the Water Tank Electric Heater

a. when the water tank temperature set point is lower than the maximum value of the water heating range of the main unit, the auxiliary electric heater of the main unit will run depending on the temperature difference, and the water tank keeps shut-down.

b. when the water tank temperature set point is higher than the maximum value of the water heating

range of the main unit but the actual water tank temperature is lower than the maximum value of the water heating range of the main unit, the auxiliary electric heater of the main unit will run depending on the temperature difference. If the actual water tank temperature is higher than the maximum value of the water heating range of the main unit, the water tank heater will start. At any time, only one between the auxiliary electric heater and the water tank heater is allowed to run.

Over-temperature Protection for Water Heating

When the compressor is running, if it is detected that the leaving water temperature of the auxiliary electric heater of the main unit is higher than the over-temperature protection temperature, the compressor will lower its operating frequency until it reaches the minimal operating frequency. At this point, if it is still detected that leaving water temperature is still lower than the over-temperature protection, all loads except the water pump of the main unit and the 4-way valve will stop. Over-temperature protection will exit when the leaving water temperature is lower than the over-temperature protection temperature. Then, the main unit will resume normal operation.

2.3.2 Water Heating by the Solar System

When the solar water heating system is equipped but temperature difference (it is the difference of solar panel temperature and the actual water tank temperature) for startup is not satisfied, the water pump of the solar system will not start. When the temperature difference is satisfied, the water pump will start. However, when it is detected that the water tank temperature reaches the set point, or the entering/leaving water temperature difference of the solar panel is too small, then this water pump will stop running.

2.4 Shutdown

There are three kinds of shutdown conditions: normal shutdown, shutdown with some error, shutdown for protection

Shutdown sequence: for normal shutdown, the compressor lowers its frequency firstly to the minimum value, while for shutdown with some error or for protection, the compressor will stop directly. Then, the electrostatic expansion valve turns to the maximum opening angle; the fan stops after the compressor has stopped; the water pump of the main unit stops after the compressor has stopped; the electrostatic expansion valve turns the maximum opening angle to the fixed opening angle.

During shutdown under the heating and water heating modes, the 4-way valve will be powered off after the compressor has stopped.

For shutdown owing to some error (except the communication error) or protection, the 4-way valve will keep the power-on status.

For shutdown owing to communication between the unit and the wired controller, the 4-way valve will be powered off some timer later.

For shutdown with some error or for protection, the electrostatic expansion valve will keep the maximum opening angle.

2.5 Control to the Compressor

When the unit is controlled by the leaving water temperature, the output frequency of the compressor is adjusted by the difference between the actual water temperature and the leaving water temperature set point. When the unit is controlled by the room temperature, the output frequency of the compressor is adjusted by the difference between the actual room temperature and the room temperature set point.

2.6 Control to the Fan

Under the cooling mode, the operating frequency of the fan is adjusted according to pressure at the high pressure side. Under the heating or water heating mode, the operating frequency of the fan is adjusted according to the pressure at the low pressure side. During defrosting, the fan stops and resumes operation when defrosting ends up.

2.7 Control to the 4-way Valve

The 4-way valve always keeps on under the cooling mode and will off after the compressor starts up under the heating or water heating mode. When the unit comes into defrosting, the 4-way valve will be on and resume the off status when defrosting ends up. For shutdown under the heating mode, the 4-way valve will be closed after the compressor stops.

2.8 Control to the Water Pump

The water pump firstly will run at the initialized speed and then adjust the speed according to the entering/leaving water temperature difference. When the temperature difference is large, the fan runs at the high speed. When the temperature difference is small, the fan runs at the low speed.

2.9 Control the Electrostatic Expansion Valve

There are two electrostatic expansion valves for two-stage throttling control. The opening angle of the first-stage electrostatic expansion valve is adjusted based on the ratio of readings of the high-pressure sensor, low-pressure sensor and enthalpy-adding sensor. The opening angle of the second-stage is adjusted based on the suction superheating degree.

2.10 Protection Control

(1) Compressor Low-pressure Protection

When it is detected continuously that pressure at the low side is too low, then low-pressure protection will occur and this error will be displayed at the controller, all loads act as per the shutdown sequence. This error is unrecoverable and can be cleared unless repowered on.

(2) High Discharge Temperature Protection

When it is detected continuously that the discharge temperature is higher than the recoverable temperature, the electrostatic expansion valve will turn to the maximum opening angle with large step until the discharge temperature is lower than the recoverable temperature. However, if this condition remains, the compressor will restrict the frequency output or lower its frequency three times. At any time, if it is detected that the discharge temperature is higher than the set point for protection for three seconds, the compressor will stop and the unit comes into high discharge temperature protection.

(3) Compressor Hi-pressure Protection

In any case, when it is detected that the high-pressure switch acts, the unit will come into high-pressure protection three seconds later. This protection is unrecoverable.

(4) Flow Switch Protection

In any case, when it is detected that the flow switch of the main unit disconnects, then all loads except the water pump of the solar system and the auxiliary electric heater of the water tank will stop. This protection is unrecoverable. The unit is allowed to be restart only after this error is cleared and the unit is repowered on.

(5) Communication Error

When the indoor unit main board or drive board does not receive correctly any data from the unit main board, all loads will stop.

3 Controller

3.1 General

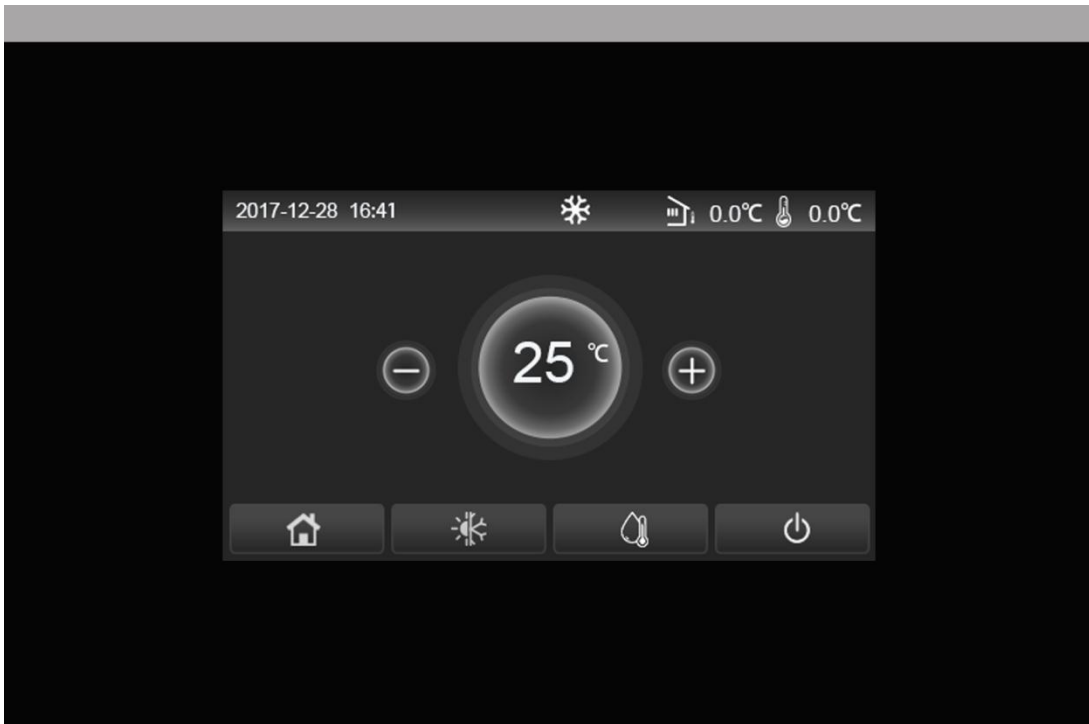

(This picture is just for reference)











This display panel uses the capacitor touch screen for input operation. The valid touching area indicates the black rectangle when the display panel lights off.

This control panel is of high sensitivity and will response to unexpected click by the foreign matters on the display panel. Therefore, please keep it clean during operation.

This is a generous-purpose controller, whose control functions might not be completely the same as those of the actually purchased. As the control program will update, the actual always prevails.

3.1.1 Homepage



Icon	Description	Icon	Description
	Space heating		Outdoor temperature
	Space cooling		Leaving water temperature of the main unit, leaving water temperature of the auxiliary electric heater, remote room temperature
	Water heating		Error
	Menu		Card out/Failed disinfection
	Switchover between cooling and heating		ON/OFF

[Notes]

- The “ON/OFF” icon will turn to green when the control is turned on.
- When the control mode is “Room temperature”, the temperature displayed at the upper right corner indicates the remote room temperature; when the control mode is “leaving water temperature”, it indicates the leaving water temperature of the auxiliary electric heater under the water heating mode, or the leaving water temperature of the main unit under the cooling/heating mode or combined modes.
- Under the combined modes, the temperature set point is for space heating or cooling. Only under the water heating mode, it is for water heating.
- It will go back automatically to the homepage when there is no any operation in ten minutes.



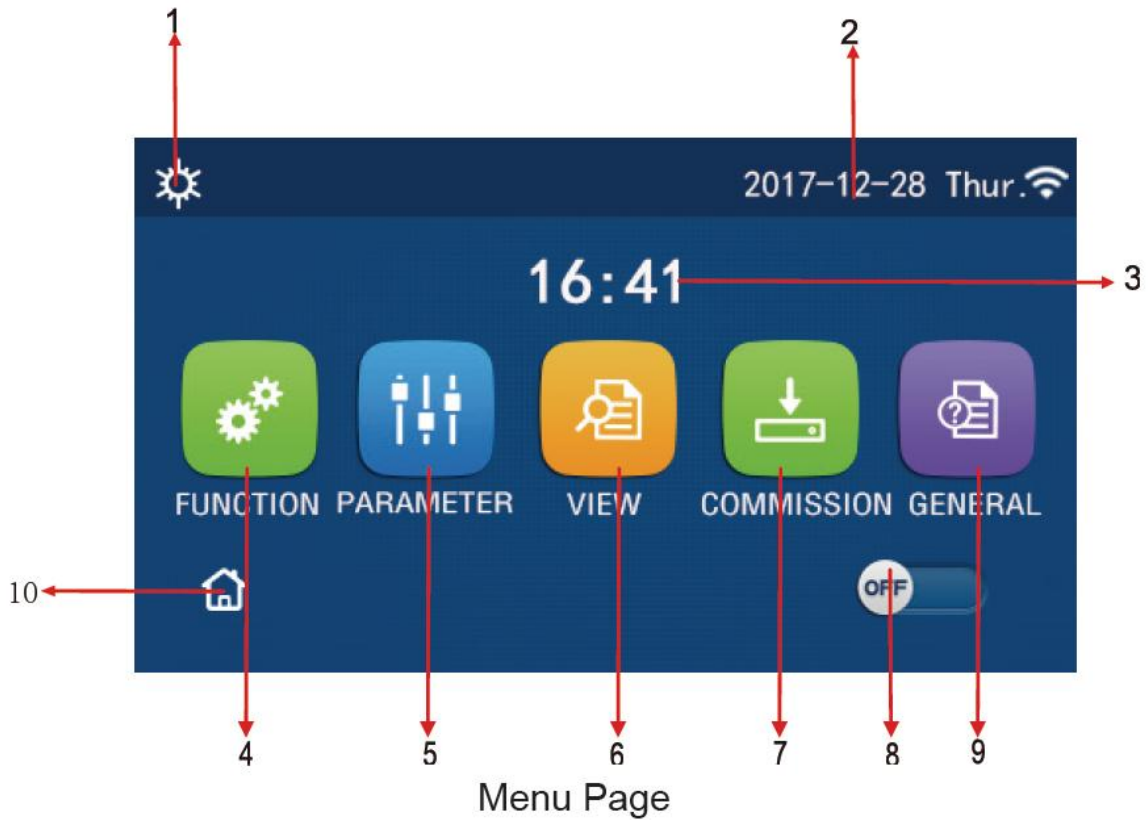

















3.1.2 Menu Page



Above the menu, the corresponding icon will be displayed based on the mode and status of the controller.

Menu Page

No	Item	Description
1	Current mode	Current mode
2	Data	Current data
3	Time	Current time
4	Function setting	Go to the user setting page.
5	Parameter setting	Go to the parameter setting page.
6	Parameter viewing	Go to the parameter viewing page.
7	Commissioning parameters	Go to the commissioning parameter setting page.
8	ON/OFF	It is used to turn on or off the unit. "OFF" indicates the unit has turned off and "ON" indicates the unit has turned on. When there is failure-level error, this button will turn to OFF once the unit is automatically turned off.
9	General setting	Go to the general parameter setting page.
10	Homepage	Back to the home page.

Icon	Description	Icon	Description
	Heating		Floor commissioning
	Cooling		Floor commissioning error
	Hot water		Card out
	Heating + Hot water		Defrosting
	Hot water + Heating		Holiday
	Cooling + Hot water		WiFi
	Hot water + Cooling		Back
	Quiet		Menu page
	Sanitation		Save
	Emergency		Error

[Notes]

- The “Cooling” mode is unavailable to the heating only unit.
- The “Hot water” mode is unavailable to the heating only unit.
- The “Heating + Hot water” (“Hot water” takes the priority) is unavailable to the mini chiller.
- The “Hot water + Heating” (“Heating” takes the priority) is unavailable to the mini chiller.
- The “Cooling + Hot water” (“Hot water” takes the priority) is unavailable to the mini chiller.
- The “Hot water + Cooling” (“Cooling” takes the priority) is unavailable to the mini chiller.
- The “Sanitation” function is unavailable to the mini chiller.

- As shown in the figure below, the error icon will appear at the upper left corner when any error exists.



Error Icon

[Notes]

- At any other page, where there is no operation in 10 minutes, the display panel will back to the menu page.

3.1.3 Backlight

Among the general setting page, when “Back light” is set to “Energy save”, the display panel will light off when there is no operation in 5 minutes. However, it will light on again by touching any valid area.

When “Back light” is set to “Lighted”, the display panel will be kept lighting on.

It is suggested to set it to “Energy save” so as to extend its service life,

3.2 Operation Instructions

3.2.1 ON/OFF

[Operation Instructions]

- ★At the menu page, by touching ON/OFF, the unit will be turned on/off.

[Notes]

- It is defaulted to be OFF upon first power-on.
- ON/OFF operation will be memorized by setting “On/Off Memory” to be “On” at the “GENERAL.” setting page. That is, in case of power failure the unit will resume running upon power recovery. Once “On/off Memory” is set to be “Off”, in case of power failure the unit will keep “Off” upon power recovery.

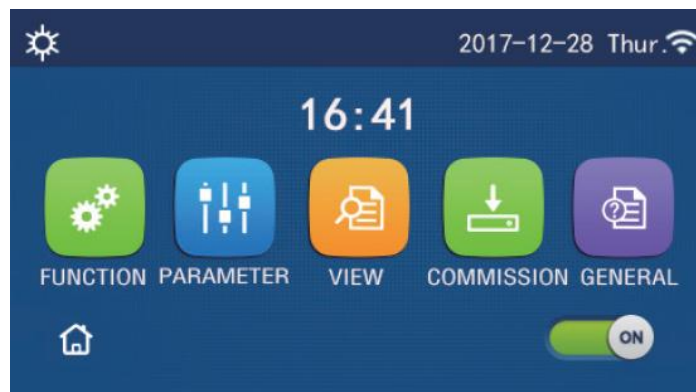

ON Page

3.2.2 Function Setting

[Operation Instructions]

★1. At the menu page, by touching “FUNCTION”, it will go to the function setting page as shown in the figure below.

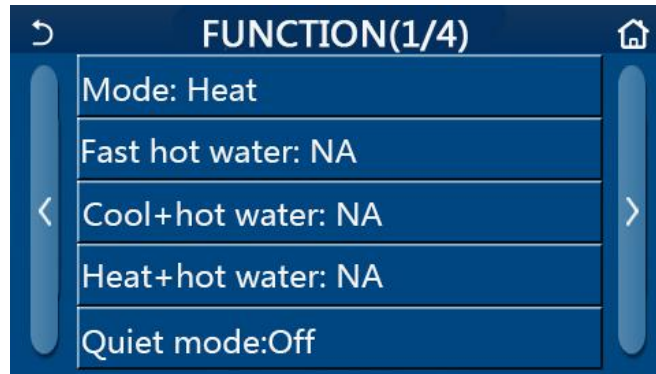

FUNCTION Setting Page

★2. At the function setting page, by touching the page turning key, it will access to the last or next page. When setting is finished, by touching the homepage icon, it will directly back to the homepage; by touching the back icon, it will back to the upper menu.

★3. At the function setting page, by pressing the desired function, it will access to the corresponding setting page of this option.

★4. At the function setting page of some function option, by touching “OK”, this setting will be saved; by touching the “CANCEL” key, this setting will be canceled.

[Notes]

●At the function setting page with setting of any function changed, if the function is set to be memorized upon power failure, this setting will be saved automatically and memorized upon next power-on.

●When there is submenu for the selected function option, by pressing it the control will go directly the setting page of the submenu.

Function Setting

No	Item	Range	Default	Remarks
1	Mode	Cool	Heat	1. When the water tank is unavailable, then only “Cool” and “Heat” are available. 2. For the heating only unit, only “Heat” mode, “Hot water”, and “Heat + hot water” are available.
		Heat		
		Hot water		
		Cool + Hot water		
		Heat + Hot water		
2	Fast hot water	On/Off	Off	1. When the water tank is unavailable, it will be reserved.
3	Cool + hot water	Cool/Hot water	Cool	1. When the water tank is available, it will be defaulted to be “Hot water”; when unavailable, it will be reserved.
4	Heat + hot water	Heat/Hot water	Heat	1. When the water tank is available, it will be defaulted to be “Hot water”; when unavailable it will be reserved.
5	Quiet mode	On/Off	Off	
6	Quiet timer	On/Off	Off	

No	Item	Range	Default	Remarks
7	Weather depend	On/Off	Off	
8	Weekly timer	On/Off	Off	
9	Holiday release	On/Off	Off	
10	Disinfection	On/Off	Off	When the water tank is unavailable, it will be reserved 1. The disinfection date ranges from Monday to Sunday. Saturday is defaulted. 23: 00. 2. The disinfection time ranges from 00:00~23:00. 23:00 is defaulted.
11	Clock timer	On/Off	Off	
12	Temp. timer	On/Off	Off	
13	Emergen. mode	On/Off	Off	
14	Holiday mode	On/Off	Off	
15	Preset mode	On/Off	Off	
16	Error reset	/	/	Some error can be cleared only when it has been reset manually.
17	WiFi reset			It is used to reset the WiFi.
18	Reset	/	/	It is used to reset all user parameter setting.

3.2.2.1 Mode

[Operation Instructions]

★At the function setting page with the unit turned off, by touching “**Mode**”, it will go to the mode setting page, where desired mode can be selected. Then by touching “OK” this setting will be saved and the display panel will back to the function setting page.

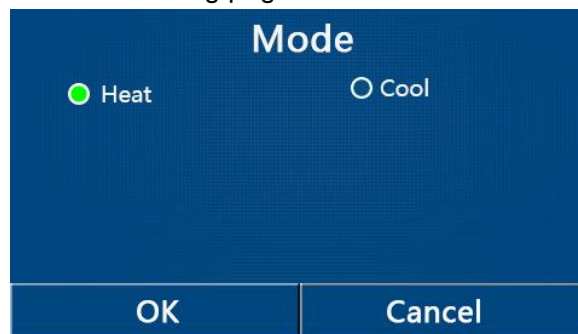

[Notes]

- The default mode is “**Heat**” upon first power-on.
- Mode setting is allowed only when the unit is turned off, otherwise a dialog box will pop up, saying “**Please turn off the system first!**”
- When the water tank is unavailable, only ‘**Heat**’ and “**Cool**” mode are allowed.
- When the water tank is available, “**Cool**”, “**Heat**”, “**Hot water**”, “**Cool+ Hot water**”, and “**Heat+ Hot water**” are allowed.

- For the heat pump, the “**Cool**” mode is allowed; for the heating only unit, “**Cool+ Hot water**” and “**Cool**” are unallowable.
- This setting can be memorized upon power failure.

3.2.2.2 Fast Hot Water

[Operation Instructions]

★ At the function setting page with the unit turned off, by touching “**Fast hot water**”, the display panel will go to the corresponding setting page, where desired option can be selected. Then by pressing “**OK**” this setting will be saved and the display panel will back to the function setting page.

[Notes]:

- This function can be set to “**On**” only when the water tank is available. When the water tank is unavailable, this function will be reserved.
- It will be memorized upon power failure.

3.2.2.3 Cool + hot water

[Operation Instructions]

★ At the function setting page with the unit turned off, by touching “**Cool + hot water**”, the display panel will go to the corresponding setting page, where desired option can be selected. Then by pressing “**OK**” this setting will be saved and the display panel will back to the function setting page.

[Notes]

- When the water tank is unavailable, it will be reserved; when it is unavailable, the default priority will be given to “**How water**”.
- It will be memorized upon power failure.

3.2.2.4 Heat + hot water

[Operation Instructions]

★ At the function setting page with the unit turned off, by touching “**Heat + hot water**”, the display panel will go to the corresponding setting page, where desired option can be selected. Then by pressing “**OK**” this setting will be saved and the display panel will back to the function setting page.

[Notes]

- When the water tank is unavailable, it will be reserved; when it is unavailable, the default priority will be given to “**How water**”.
- It will be memorized upon power failure.

3.2.2.5 Quiet Mode

[Operation Instructions]

- ★ At the function setting page with the unit turned off, by touching “**Quiet mode**”, there will be a choice box, where “Quiet mode” can be set to “On”, “Off”, or “Timer”.
- ★ When it is set to “**Timer**”, it is also required to set the “**Start timer**” and “**End timer**”. Unless otherwise stated, otherwise time setting is all the same.

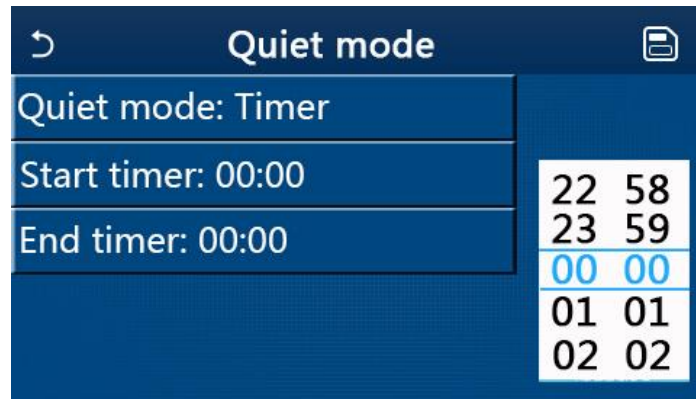

Timer for Quite Mode

★ 3. This setting will be saved by touching the corner at the upper right corner.

[Notes]

- It can be set under both ON and OFF statuses, but will work only when the main unit is turned on.
- When it is set to “On”, it will automatically back to “Off” when the main unit is turned off; while it is set to “Timer”, this setting will remain when the main unit is turned off and can only be canceled manually.
- It will be memorized upon power failure.

3.2.2.6 Weather Depend

[Operation Instructions]

★ At the function setting page, by touching “**Weather depend**”, there will be a choice box, where it is able to set it to “On” or “Off”, and also it is able to set the weather-dependent temperature.

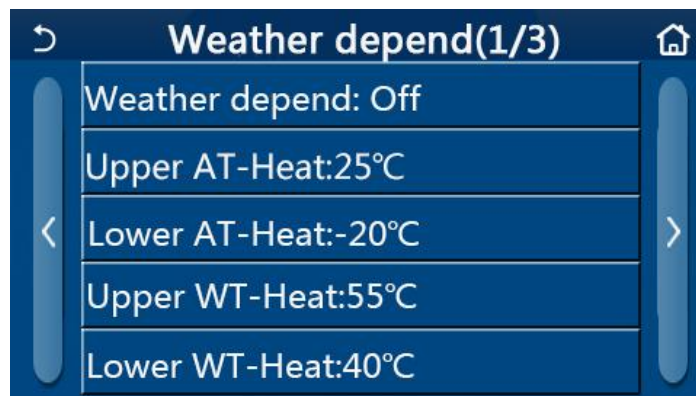

Page of the Weather Depend

[Notes]

- When “**Weather depend**” has been activated; it cannot be deactivated by ON/OFF operation but done manually.
- It is available to find the weather-dependent target temperature at that parameter viewing pages.
- When this function has been activated, it is still allowed to set the room temperature, however, this setting becomes valid only when “**Weather depend**” has been deactivated.
- This function can be set to “On” no matter the unit is turned on or off, but works only when the unit is turned on.
- This function only works for air conditioning. Under the “**Hot water**” mode, it cannot be activated.
- It will be memorized upon power failure.

3.2.2.7 Weekly Timer

[Operation Instructions]

★1. At the function setting page, by touching “**Weekly timer**”, it will go to the setting page as shown below.

Weekly timer	
Weekly timer: Off	
Mon. : Invalid	Tue. : Invalid
Wed. : Invalid	Thur. : Invalid
Fri. : Invalid	Sat. : Invalid
Sun. : Invalid	

★2. At the “**Weekly timer**” setting page, as shown in the figure below, the weekly timer can be set to “**On**” or “**Off**”.

★3. At the “**Weekly timer**” setting page, by touching the desired day (Monday ~ Sunday) it will access to the setting page of this option.

★4. At the weekday setting page, it is able to set the timer to “**Valid**” or “**Invalid**”. Also, it is able to set three timing periods, each of which can be set to “**Valid**” or “**Invalid**”.

★5. Then, by touching the “**Save**” icon, this setting will be saved.

[Notes]

- Three periods can be set for each day. The start time should be earlier than the end time for each period, otherwise this setting will be invalid. In the same way, the latter should be earlier than the former.

- When the weekly timer has been activated, the display panel will act based on the current mode and temperature setting.

- Timer setting for the weekday

“**Valid**” it indicates this setting works only when “**Weekly timer**” has been activated, unaffected by the holiday mode.

“**Invalid**” indicates this setting does not work even though the “**Weekly timer**” has been activated.

- It will be memorized upon power failure.

3.2.2.8 Holiday Release

[Operation Instructions]

★At the function setting page, by touching “**Holiday release**”, it will go to the corresponding setting page, where it can be set to “**On**” or “**Off**”.

[Notes]

- When this function has been activated, at the “**Weekly timer**” setting page, some week day can be set to “Holiday release”. In this case, the setting of the “Weekly timer” at this day is invalid unless it has been manually set to “**Valid**”.

- It will be memorized upon power failure.

3.2.2.9 Disinfection

[Operation Instructions]

★At the function setting page, access to “**Disinfection**” setting page.

★At the “**Disinfection**” setting page, it can select the disinfection clock, disinfection temperature and disinfection week and the corresponding setting page will pop up at the right side.

★Then, this setting will be saved by touching the “**Save**” icon.



[Notes]

- This setting can be activated only when “**Water tank**” is set to “**With**”. When “**Water tank**” is set to “**Without**”, this function will be deactivated.
- This setting can be done no matter if the unit is turned on or off.
- When “**Emergen.mode**”, “**Holiday mode**”, “**Floor debug**”, “**Manual defrost**”, or “**Refri. recovery**” has been activated, this function cannot be activated at the same time. When “**Disinfection**” has been activated, “**Emergen.mode**”, “**Holiday mode**”, “**Floor debug**”, “**Manual defrost**”, or “**Refri. recovery**” setting will fail and a window will pop up, saying “**Please disable the disinfect mode!**”
- “**Disinfection**” can be activated no matter if the unit is turned on or off. This mode will take priority over the “**Hot water**” mode.
- When disinfection operation fails, the display panel will tell “**Disinfection fail!**”. Then, by pressing OK it will be cleared.
- When “**Disinfection**” has been activated, if communication error with the indoor unit or malfunction of the water tank heater occurs, it will automatically quit.
- It will be memorized upon power failure.

3.2.2.10 Clock Timer

[Operation Instructions]

★ At the function setting page, access to the “**Clock timer**” setting page.

★At the “**Clock timer**” setting page, it can be set to “**On**” or “**Off**”.

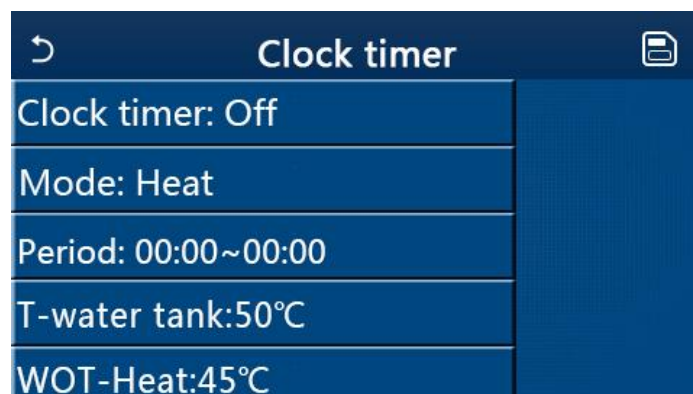

★ The option “**Mode**” is used to time the desired mode; “**WOT-Heat**” and “**T-water tank**” is used to set

the corresponding water temperature; **“Period”** is used to for time setting. After that, by touching the **“Save”** icon, all settings will be saved.



[Notes]

- When **“Clock timer”** has been set and **“Hot water”** mode is involved, in this case, if **“Water tank”** is changed to **“Without”**, **“Hot water”** will be automatically switched to **“Heat”**, and **“Cool/Heat + Hot water”** will be switched to **“Cool/Heat”**.
- When **“Weekly timer”** and **“Clock timer”** have been set at the same time, the priority will be given to the former.
- When the water tank is available, **“Heat”**, **“Cool”**, **“Hot”**, **“Heat + Hot water”**, and **“Cool + Hot water”** are allowed; however, when the water tank is unavailable, only **“Heat”** and **“Cool”** are allowed.
- When the end time is earlier than the start time, this setting is invalid.
- Water tank temperature can be set only when **“Hot water”** is involved in the operation mode.
- The setting of **“Clock timer”** only works once. If this setting is needed again, it should be set again.
- It will be deactivated when the unit is turned on manually.
- This function will be memorized upon power failure.

3.2.2.11 Temp. Timer

- ★ At the function setting page, access to the **“Temp.timer”** setting page.
- ★ At the **“Temp.timer”** setting page, it can be set to **“On”** or **“Off”**.

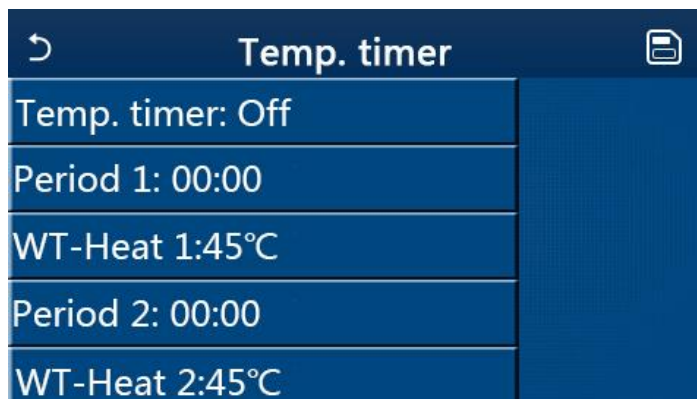

- ★ Select **“Period 1”/“Period 2”** and a window will pop up, where time period can be set. Then select **“WT-Heat1/WT-Cool 1/2”** and also a window will pop up where temperature can be set”.



[Notes]

- When “**Weekly timer**”, “**Preset mode**”, “**Clock timer**” “**Temp. timer**” have been set at the same time, then the latter takes the priority.
- This setting is valid only when the unit is turned on.
- Under the “**Cool**” or “**Cool+Hot water**” mode, the setting targets at “**WT-Cool**”; while under the “**Heat**” or “**Heat+Hot water**” mode, the setting targets at “**WT-Heat**”.
- When start time of period 2 is the same as that of period 1, then the former takes prevalence.
- “Temp.timer” is judged based on timer.
- During this setting, when temperature is set manually, then this setting will take prevalence.
- Under the “Hot water” mode, this function will be reserved.
- This function will be memorized upon power failure.

3.2.2.12 Emergen. Mode

[Operation Instructions]

- ★At the function setting page, set the mode to “**Heat**” or “**Hot water**”.
- ★At the function setting page, select “**Emergen.mode**” and set it to “**On**” or “**Off**”.
- ★When “**Emergen.mode**” has activated, the corresponding icon will appear at the upper side of the menu page.
- ★When the mode is not set to “**Heat**” or “**Hot water**”, the display panel will tell “**Wrong running mode!**”

[Notes]

- The emergency mode is allowed on conditions that there is some error or protection and the compressor has stopped at least for three minutes. If the error or protection has not been recovered, the unit can access to the emergency mode through the wired controller (when the unit is off).
- Under the emergency mode, “**Hot water**” or “**Heat**” cannot be performed at the same time.
- When the running mode is set to “**Heat**”, if “**Other thermal**” or “**Optional E-Heater**” is set to “**Without**”, the unit will fail to access to the “**Emergen. mode**”.
- When the unit performs “**Heat**” under “**Emergen. mode**” and the controller detects “**HP-Water Switch**”, “**Auxi. heater 1**”, “**Auxi. heater 1**”, and “**Temp-AHLW**”, this mode will quit at once. In the same way, when errors mentioned above occur, “**Emergen. mode**” cannot be activated.
- When the unit performs “**Hot water**” under “**Emergen. mode**” and the controller detects “**Auxi.-WTH**”, this mode will quit at once. In the same way, when errors mentioned above occur, “**Emergen. mode**” cannot be activated.
- When this function has been activated, “**Weekly timer**”, “**Preset mode**”, “**Clock timer**”,and “**Temp timer**” will be deactivated. Beside “**On/Off**”, “**Mode**”, “**Quiet mode**”, “**Weekly timer**”, “**Preset mode**”, “**Clock timer**”,and “**Temp timer**” operation are unavailable.
- Under “**Emergen. mode**”, the thermostat does not work.
- This function can be activated only when the unit is turned off. If dosing so with the unit keeping “**On**”,

a window will pop up, saying “**Please turn off the system first!**”.

- “**Floor debug**”, “**Disinfection**”, and “**Holiday mode**” cannot be activated at the same with this function. When doing so, a window will pop up, saying “**Please disable the emergen. mode!**”.
- Upon power failure, “**Emergen. mode**” will back to “**Off**”.

3.2.2.13 Holiday Mode

[Operation Instructions]

★At the function setting page, select “**Holiday mode**” and set it to “On” or “Off”.

[Notes]

- This function can be activated only when the unit has been turned off, otherwise a prompt dialog box will pop up, saying “**Please turn off the system frist!**”.
- When “**Holiday mode**” has been activated, the operation mode will automatically switch to “**Heat**”. Mode setting and “**On/Off**” operation through the controller will be unavailable.
- When “**Holiday mode**” has been activated, the controller will automatically deactivate the “**Weekly timer**” and “**Preset mode**”and “**Clock timer**” and “**Temp.timer**”.
- Under the “**Holiday mode**”, when the unit is under the control of room temperature, the set point (room temperature for heating) should be set to 10°C; when it is under the control of leaving water temperature, the set point (leaving water temperature for heating) should be 30°C.
- When this function has been activated, “**Floor debug**”, “**Emergen.mode**”, “**Disinfection**”, “**Manual defrost**”, “**Preset mode**”, “**Weekly timer**”, “**Clock timer**”, and “**Temp.timer**” cannot be activated at the same time, meanwhile a window will pop up, saying “**Please disable the holiday mode!**”.
- This function will be memorized upon power failure.

3.2.2.14 Preset Mode

[Operation Instructions]

★ At the function setting page, select “**Preset mode**” and go to the corresponding setting page.

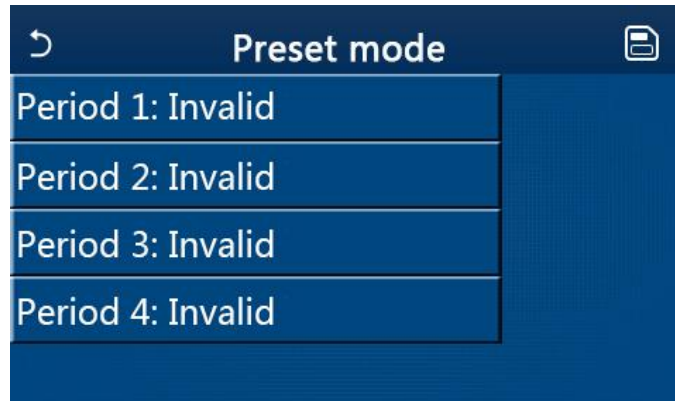

★ At the time period setting page, each time period can be set to “**Valid**” or “**Invalid**”.

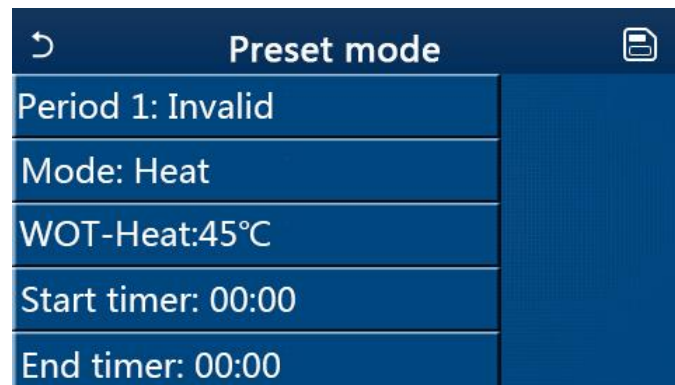

★ The option “**Mode**” is used to preset the mode; “**WOT-Heat**” is used to set the leaving cold/hot water temperature; “**Start timer**” / “**End timer**” is used to for time setting. After that, by touching the “**Save**” icon, all settings will be saved.

[Notes]:

- When “**Preset mode**” has been set to “**Hot water**” and “**Water tank**” is to set to “**Without**”, the preset “**Hot water**” mode will be automatically switched to “**Heat**”.
- When “**Weekly timer**” and “**Preset mode**” both have been set, priority will be given to the latter.
- When the water tank is available, the preset mode can be “**Heat**”, “**Cool**”, or “**Hot water**”; however, when the water tank is unavailable, the preset mode can only be “**Heat**” or “**Cool**”.
- “**Start timer**” should be earlier than “**End timer**”, otherwise a dialog will pop up, saying “time setting wrong”.
- The setting for “**Preset mode**” will works until it has been canceled manually.
- When “**Start timer**” is reached, the unit will perform the preset mode. In this case, mode and temperature setting are still allowed but will not be saved to the preset mode. When “**End timer**” is reached, the unit will perform OFF operation.
- This function will be memorized upon power failure.

3.2.2.15 Error Reset

[Operation Instructions]

★ At the function setting page, by touching “**Error reset**”, a choice box will pop up, where by touching “**OK**” the error will be reset and by touching “**Cancel**” the error will not be reset.

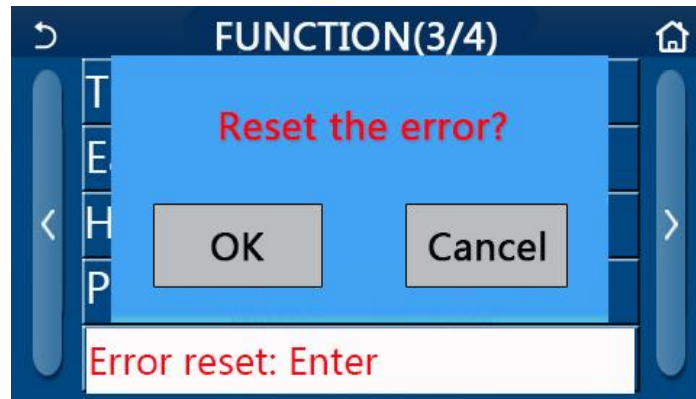

[Notes]:

- It can be performed only when the unit is turned off.

3.2.2.16 WiFi Reset

[Operation Instructions]

★At the function setting page, by touching “WiFi”, a choice box will pop up, where by touching “OK”, the WiFi setting will be reset, and by touching “Cancel” the choice box will quit and WiFi will not be reset.

3.2.2.17 Reset

[Operation Instructions]

★At the function setting page, by touching “Reset”, a choice box will pop up, where by touching “OK” all user parameter settings will be reset and by touching “Cancel” it will back to the function setting page.

[Notes]:

- This function is allowed only when the unit has turned off.
- This function is valid for “Temp. timer”, “Clock timer”, “Preset mode”, “Weekly timer”, and “Weather depend”.

3.2.3 User Parameter Setting

[Operation Instructions]

★1. At the menu page, by touching “PARAMETER”, it will back to the parameter setting page, as shown in the figure below.

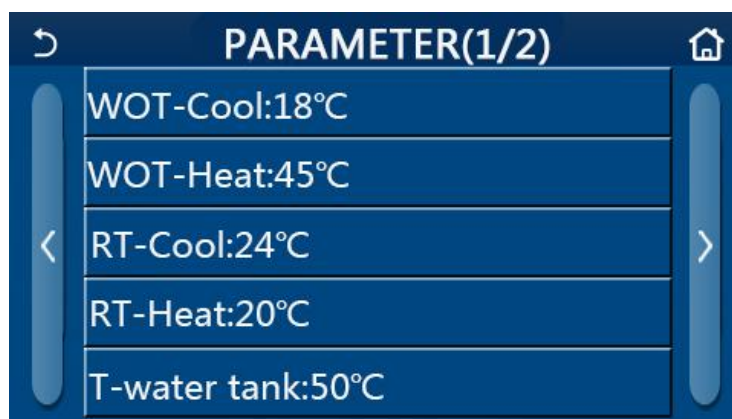

Parameter Setting Page

★2. At the menu setting page, by touching the page turning keys, it is able to switch to the page where the desired parameter is.

★3. After that, this setting will be saved by touching “OK” and then the unit will run based on this setting. While this setting will give up by touching “Cancel”.

[Notes]:

- For parameters with different defaults under different conditions, when conditions changes, the

default value also will change as the corresponding condition changes.

- All parameters will be memorized upon power failure.

Parameter Setting

No	Full Name	Displayed Name	Range	Range	Default	Remarks
			(°C)	(°F)		
1	Leaving water temperature for cooling(T1)	WOT-Cool	7~25°C	45~77°F	18°C/64°F	
2	Leaving water temperature for heating (T2)	WOT-Heat	20~60°C	68~140°F	45°C/113°F	High-temp series units
3	Room temperature for cooling (T3)	RT-Cool	18~30°C	64~86°F	24°C/75°F	
4	Room temperature for heating (T4)	RT-Heat	18~30°C	64~86°F	20°C/68°F	
5	Water tank temperature(T5)	T-water tank	40~80°C	104~176°F	50°C/122°F	
6	Leaving water temperature difference for cooling (Δt_1)	ΔT -Cool	2~10°C	36~50°F	5°C/41°F	
7	Leaving water temperature difference for heating (Δt_2)	ΔT -Heat	2~10°C	36~50°F	10°C/50°F	
8	Leaving water temperature difference for water heating (Δt_3)	ΔT -hot water	2~8°C	36~46°F	5°C/41°F	
9	Room temperature control difference (Δt_4)	ΔT -Room temp	1~5°C	34~41°F	2°C/36°F	

3.2.4 Commissioning Parameter Setting

[Operation Instructions]

★1. At the menu page, by touching “**Commission**”, it will access to the commissioning parameter page, where the left side is for the function setting and the right side is for the parameter setting, as shown in the figure below.

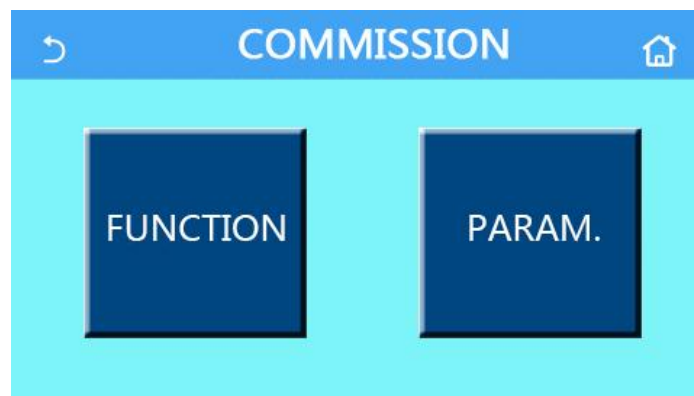

[Notes]

- At the commissioning parameter setting page, when the state of any function changes, the system

will automatically save this change and this change will remain upon power failure.

- Do not modify any commissioning parameter except the approved qualified servicemen, as it would give birth to adverse effects to the unit.

Commissioning Function Setting

No	Item	Range	Default	Description
1	Ctrl. state	T-water out/T-room	T-water out	When " Remote sensor " is set to " With ", it can be set to " T-room ".
2	2-Way valve	Cool 2-Way valve, On/Off	Off	It will decide the status of the 2-way valve under the " Cool " and " Cool + Hot water " modes.
		Heat 2-Way valve, On/Off	On	It will decide the status of the 2-way valve under the " Heat " and " Heat + Hot water " modes
5	Solar setting	With/Without	Without	<ol style="list-style-type: none"> 1. When the water tank is unavailable, this setting will be reserved. 2. When it is set to "With", the solar kitting will work on its own. 3. When it is set to "Without", hot water by the solar kitting is unavailable.
6	Water tank	With/Without	Without	
7	Thermostat	Without/Air/Air+ hot water	Without	<ol style="list-style-type: none"> 1. This setting cannot be interchanged between "Air" and "Air+ hot water" directly but via "Without" this option 2. Each time when "Air" or "Air + hot water" is switched to "Without", the unit will go to the OFF status. Meanwhile, the control will send out "OFF" command for consecutive 40 seconds (it is longer than the communication error, and the "ON" command can be performed only when 40 seconds have been expired.
8	Other thermal	With/Without	Without	
9	Optional E-Heater	Off/1/2	Off	
10	Remote sensor	With/Without	Without	When it set to "Without", and the "Ctrl. state" will be defaulted to be "T-water out".
11	Air removal	On/Off	Off	
12	Floor debug	On/Off	Off	
13	Manual defrost	On/Off	Off	
14	Force mode	Off/Force-cool/Force-heat	Off	
15	Tank heater	Logic 1/Logic 2	Logic 1	This setting is allowed when the water tank is

Control

No	Item	Range	Default	Description
				available and the unit is OFF.
16	Gate-Ctrl.	On/Off	Off	
17	C/P limit	Off/Current limit/Power limit	Off	Current limit: it ranges from 0 to 50A and the default is 16A. Power limit: it ranges from 0.0 to 10.0kW and the default is 3.0kW.
18	Address	[1-125] [127-253]	1	
19	Refri. recovery	On/Off	Off	
20	Gate-Ctrl memory	On/Off	Off	

Commissioning Parameters Setting

No	Full Name	Display Name	Range		Default	Remark
1	T-HP max	T-HP max	40~55℃	104~131℉	50℃/122℉	
2	Cool run time	Cool run time	1~10min		3min [2-way valve Off] 5min [2-way valve On]	
3	Heat run time	Heat run time	1~10min		3min [2-way valve Off] 5min [2-way valve On]	

3.2.4.1 Ctrl. state

[Operation Instructions]

- ★ At the commissioning parameter setting page, by touching “**Ctrl. state**”, it can be set to “**T-water out**” or “**T-room**”



[Notes]

- When “**Remote sensor**” is set to “**With**”, this setting can be set to “**T-water out**” or “**T-room**”. When “**Remote sensor**” is set to “**Without**”, this setting can only be set to “**T-water out**”.
- This setting will be memorized upon power failure.

3.2.4.2 2-Way valve

[Operation Instructions]

★ At the commissioning parameter setting page, by touching **“Cool 2-Way valve”** or **“Heat 2-Way valve”**, the control panel will access to the corresponding setting page.

[Notes]

- Under **“Cool”**, or **“Cool + Hot water”** mode, **“Cool 2-Way valve”** will decide the status of the 2-way valve; while under **“Heat”** or **“Heat + Hot water”**, **“Heat 2-Way valve”** will decide the status of the 2-way valve.
- It will be memorized upon power failure.

3.2.4.3 Solar Setting

[Operation Instructions]

- ★ 1. At the commissioning parameter setting page, by touching **“Solar setting”**, the control panel will access to its submenu page.
- ★ 2. At the submenu page, **“Solar setting”** can be set to **“With”** or **“Without”**.
- ★ 3. At the submenu page, the **“Solar heater”** can be set to **“On”** or **“Off”**.



Solar Setting

[Notes]

- This setting can be done no matter if the unit is turned on or off.
- This setting is allowed only when the water tank is available. When the water tank is unavailable, this setting will be reserved.
- It will be memorized upon power failure.

3.2.4.4 Water Tank

[Operation Instructions]

★ At the commissioning parameter setting page, by touching **“Water tank”**, the control panel will access to the corresponding setting page, where **“Water tank”** can be set to **“With”** or **“Without”**.

[Notes]

- This setting will be memorized upon power failure.
- This setting will become valid only when the unit is turned off.

3.2.4.5 Thermostat

[Operation Instructions]

- ★ 1. At the commissioning parameter setting page, by touching **“Thermostat”**, the control panel will access to the corresponding setting page.
- ★ 2. At the **“Thermostat”** setting page, it can be set to **“Air”**, **“Without”** or **“Air + hot water”**. When it is set to **“Air”** or **“Air + hot water”**, the unit will run based on the mode set by the thermostat; when it is set to **“Without”**, the unit will run based on the mode set by the control panel.

[Notes]

- When “**Water tank**” is set to “**Without**”, the “**Air + hot water**” mode is unavailable.
- When “**Floor debug**” and “**Emergen.mode**” have activated, function of the thermostat will be invalid.
- When “**Thermostat**” is set to “**Air**” or “**Air + hot water**”, timer function will be disabled and the unit will run based on the mode set by the thermostat. Meanwhile, mode setting and On/Off operation will be ineffective.
- When “**Thermostat**” is set to “**Air**”, the unit will run based on the setting of the thermostat.
- When “**Thermostat**” is set to “**Air + hot water**”, when the thermostat is turned off, the unit can still perform the “**Hot water**” mode. In this case, the ON/OFF icon at the homepage does not indicate the running status of the unit. Running parameters are available at the parameter viewing pages.
- When “**Thermostat**” is set to “**Air + hot water**”, operation priority can be set by the control panel (see Section 2.2.3 and 2.2.4 for more details.)
- The status of the thermostat can be changed only when the unit is turned off.
- When it has been activated, “**Weekly timer**”, “**Clock timer**”, “**Temp.timer**”, and “**Preset mode**” cannot be activated at the same time.
- This setting will be memorized upon power failure.

3.2.4.6 Other Thermal

[Operation Instructions]

- ★1. At the commissioning parameter setting page, by touching “**Other thermal**”, the control panel will access to the corresponding setting page.
- ★2. At the “**Other thermal**” setting page, “Other thermal” can be set to “**With**” or “**Without**”, “**T-Other switch on**” can be set to the desired value. When “**Other thermal**” is set to “**With**”, it is allowed to set the operating mode for the backup thermal source.

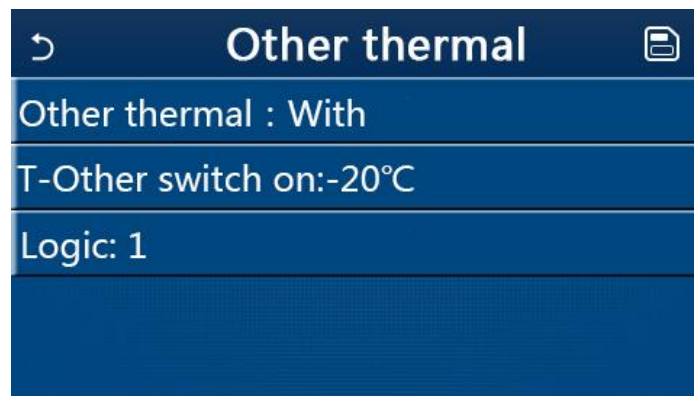

[Notes]

- This setting will be memorized upon power failure.
- There are three working logics for it.

Logic 1

1. The set point of the other thermal should be equal to that of “**WOT-Heat**” in “**Heat**” mode and “**Heat +hot water**” mode; The set point should be the smaller one between “**T-Water tank**” +5°C and 60°C in “**Hot water**” mode.
2. The water pump for other thermal must be always active under the “Heat” mode.
3. Under the “**Heat**” mode, the 2-way valve will be controlled based on the setting of the control panel. During heating operation, the water pump of the heat pump unit will be stopped; however, during standby status, the water pump will start but the other thermal will stop.

Under the “**Hot water**” mode, the 3-way valve will switch to the water tank, the water pump of the heat pump will always stop but the other thermal will start.

Under the **“Heat + Hot water”** mode, the other thermal only works for space heating, and the electric heater of the water tank works for water heating. In this case, the 2-way valve is controlled based on the setting of the control panel, and the 3-way valve will always turn to space heating system. During heating operation, the water pump of the heat pump unit will be stopped; however, during standby status, the water pump of the heat pump unit will start.

Logic 2

1. The set point of the other thermal should be equal to that of **“WOT-Heat”** and both are or lower than 60°C in **“Heat”** or **“Heat + hot water”** mode ;The set point should be the smaller one between “T-water tank” +5°C and 60°C in **“Hot water”** mode.
2. The water pump for other thermal must be always active under the **“Heat”** mode.
3. Under the **“Heat”** mode, the 2-way valve will be controlled based on the setting of the control panel. During heating operation, the water pump of the heat pump unit will be stopped; however, during standby status, the water pump will start but the other thermal will stop.

Under the **“Hot water”** mode, the 3-way valve will switch to the water tank, the water pump of the heat pump will always stop but the other thermal will start.

Under the **“Heat + Hot water”** mode (**“Heat”** takes the priority), the other thermal only works for space heating, and the electric heater of the water tank works for water heating. In this case, the 2-way valve is controlled based on the setting of the control panel, and the 3-way valve will always stop. During heating operation, the water pump of the heat pump unit will be stopped; however, during standby status, the water pump will start.

Under the **“Heat + Hot water”** mode (**“Hot water”** takes the priority), the other thermal works for space heating and water heating. The other thermal will work for water heating firstly, after reached **“T-water tank”**, other thermal turn to space heating.

Logic 3

The heat pump will only send a signal to other thermal, but all the logic of control must be “stand alone”.

3.2.4.7 Optional E-Heater

[Operation Instructions]

- ★1. At the commissioning parameter setting page, by touching **“Optional E-Heater”**, the control panel will access to the corresponding setting page.
- ★2. At the **“Optional E-Heater”** setting page, it can be set to **“1”**, **“2”** or **“Off”**.

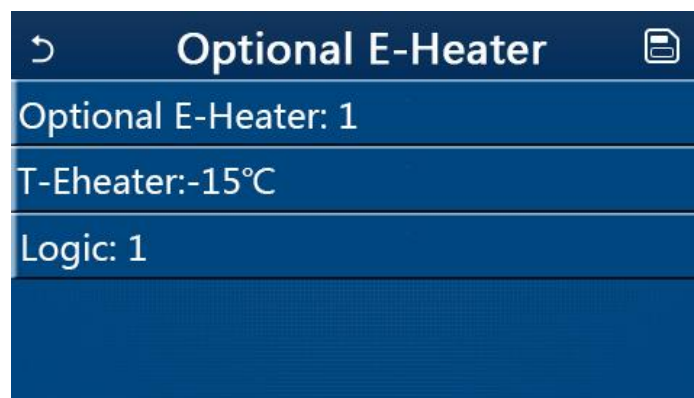

[Notes]

- This setting will be memorized upon power failure.
- Either **“Other thermal”** or **“Optional E-Heater”** can be activated at the same time.
- There are two working logics for **“Optional E-heater”**.
- Logic 1: either the heat pump or the optional electric heater can be started at the same time.
- Logic 2: both the heat pump and the optional electric heater can be started at the same time after the

compressor has run for four minutes and $T_{\text{Optional Water Temp}}$ is equal to or lower than $WOT_{\text{-heat}} - \Delta t_2$.

3.2.4.8 Remote Sensor

[Operation Instructions]

★At the commissioning parameter setting page, by touching “**Remote sensor**”, the control panel will access to the corresponding setting page, where it can be set to “**With**” or “**Without**”.

[Notes]

- This setting will be memorized upon power failure.
- Only when “**Remote sensor**” is set to “**With**”, the “**Ctrl. State**” can be set to “**T-room**”.

3.2.4.9 Air Removal

[Operation Instructions]

★At the commissioning parameter setting page, by touching “**Air removal**”, the control panel will access to the corresponding setting page, where it can be set to “**On**” or “**Off**”.

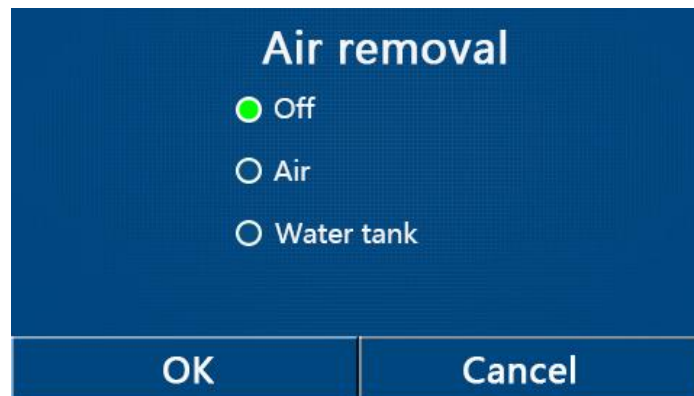

[Notes]

- This setting will be memorized upon power failure.
- This setting can be done only when the unit is turned off. And when it is set to “**On**”, the unit is not allowed to be turned on.

3.2.4.10 Floor Debug

[Operation Instructions]

★1. At the commissioning parameter setting page, by touching “**Floor debug**”, the control panel will access to the corresponding setting page.

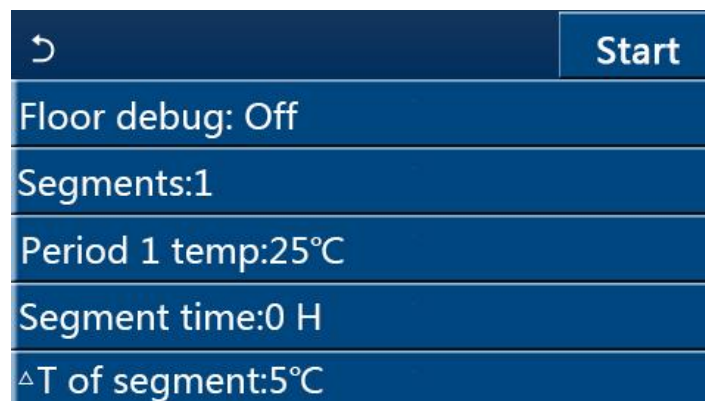

★2. At the setting page, “**Floor debug**”, “**Segments**”, “**Period 1 temp**”, “**Segment time**”, and “**ΔT of**”

segment” can be set.

No.	Full Name	Displayed Name	Range	Default	Accuracy
1	Floor debug switch	Floor debug	On/Off	Off	/
2	Quantity of segments	Segments	1~10	1	1
3	Temperature of the first segment	Period 1 temp	25~35℃/ 77~95℉	25℃/ 77℉	1℃
4	Duration of each segment	Segment time	12~72 hours	0	12 hours
5	Temperature difference of each segment	ΔT of segment	2~10℃/ 36~50℉	5℃/ 41℉	1℃

★3. When this setting is finished, by pressing **“Start”** this setting will be saved and start working, and by pressing **“Stop”** the function will halt.

[Notes]

- This function can be activated only when the unit is turned off. When it is done with the unit keeping **“On”**, a window will pop up, saying **“Please turn off the system first!”**.
- When this function has been activated, **“On/Off”** operation will be deactivated. By pressing On/Off , a window will pop up, saying **“Please disable the floor debug!”**.
- When **“Floor debug”** has been activated; **“Weekly timer”**, **“Clock Timer”**, **“Temp timer”** and **“Preset mode”** will be deactivated.
- **“Emergen. mode”**, **“Disinfection”**, **“Holiday mode”**, **“Manual defrost”**, **“Forced mode”** and **“Refri. recovery”** cannot be activated at the same time with **“Floor debug”**. If doing so, a window will pop up, saying **“Please disable the floor debug!”**.
- Upon power failure, **“Floor debug”** will back to **“Off”** and the runtime will be zeroed.
- When **“Floor debug”** has been activated, **“T-floor debug”** and **“Debug time”** can be viewed.
- When **“Floor debug”** has been activated and works normally; the corresponding icon will be displayed at the upper side of the menu page.
- Before activating **“Floor debug”**, make sure **“Segment time”** of each segment is not zero. If so, a window will pop up, saying **“Segment time wrong!”** In this case, **“Floor debug”** is allowed to be activated only when **“Segment time”** has changed.

3.2.4.11 Manual Defrost

[Operation Instructions]

★At the commissioning parameter setting page, by touching **“Manual defrost”** , the control panel will access to the corresponding setting page.

[Notes]

- This setting will not be memorized upon power failure.
- This setting can be set only when the unit has turned off. When this function has been activated, ON operation is un-allowed.
- Defrosting will quit when the defrosting temperature goes to 20℃ or the defrosting duration is equal to 10 minutes.

3.2.4.12 Force Mode

[Operation Instructions]

★1. At the commissioning parameter setting page, by touching **“Force mode”**, the control panel will access to the corresponding setting page.

★2. At the **“Force mode”** setting page, it can be set to **“Force-cool”**, **“Force-heat”**, and **“Off”**. When it is set to **“Force-cool”** or **“Force-heat”**, the control panel will directly go back to the homepage and

response to any touching operation except the ON/OFF operation, with a window popping up, saying “**The force-mode is running!**”. In this case, by touching ON/OFF, “**Force mode**” will quit.

[Notes]

- This function is allowed only when the unit has just repowered and not turned on. For the unit which once has been put into operation, this function is unavailable, alerting “**Wrong operation!**”.
- It will not be memorized upon power failure.

3.2.4.13 Gate-Ctrl.

[Operation Instructions]

★ At the commissioning parameter setting page, by touching “**Gate-Ctrl.**”, the control panel will access to the corresponding setting page.

[Notes]

• When “**Gate-Ctrl.**” has been activated; the display panel will detect the card state. When the card has inserted, the unit will run normally. When the card is drawn out, the controller will turn off the unit at once and back to the homepage. In this case, all touching operation become ineffective, and a prompt dialog box will pop up. The unit will resume normal operation until the card has inserted back and the ON/OFF status of the control panel will resume to that before the card is drawn out.

- This setting will be memorized upon power failure.

3.2.4.14 Current Limit/Power Limit

[Operation Instructions]

★1. At the commissioning parameter setting page, by touching “Current limit”, it can be set to “On” or “Off”.

★2. When it is set it “Off”, current limit and power limit both cannot be set. When it is set to “Current limit” or “Power limit”, they can be set.

★3. After that, this setting will be saved by touching the “Save” icon.

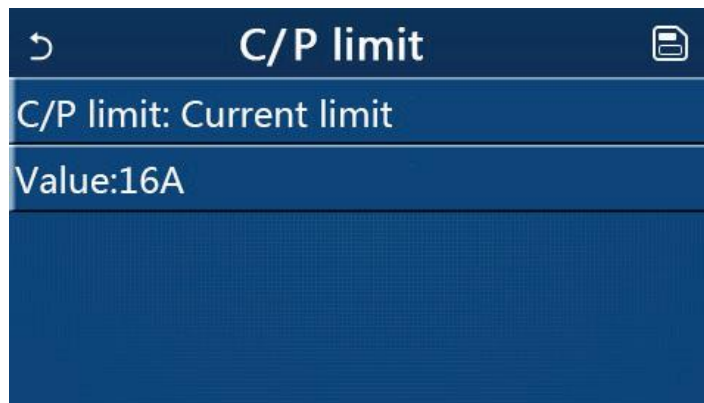

[Notes]

- This setting will be memorized upon power failure.

3.2.4.15 Address

[Operation Instructions]

★At the commissioning parameter setting page, by touching “**Current limit**”, it can be set the address.

[Notes]:

- It is used to set the address of the control panel for being integrated to the centralized control system.
- This setting will be memorized upon power failure.
- The setting range is 1~125 and 127~253.
- The defaulted address is 1 upon first power-on.

3.2.4.16 Refrigerant Recovery

[Operation Instructions]

★At the commissioning parameter setting page, by touching “**Refri. recovery**”, it will access to the refrigerant recovery page.

★ When “**Refri. recovery**” is set to “**On**”, the control panel will go back to the home page. At this time, any touch operation except ON/OFF will get no response, with a prompt dialog box popping up, saying “**The refrigerant recovery is running!**” By touching ON/OFF, refrigerant recovery will quit.

[Notes]

- This function is allowed only when the unit has just repowered and not turned on. For the unit which once has been put into operation, this function is unavailable, alerting “**Wrong operation**”.
- This function will not be memorized upon power failure.

3.2.4.17 Control Logic of the Water Tank Heater

[Operation Instructions]

At the commissioning parameter setting page, by touching “Tank heater”, it will access to the setting page of control logic for the water tank heater.

[Notes]

- “Reserved” will be displayed when the water tank is unavailable.
- This setting can be done only when the unit is off.
- This function can be memorized upon power failure.
- Logic 1: **NEVER** allowed the Unit’s Compressor and the Water Tank Electric Heater or the Optional Electric Heater to work at the same time.
- Logic 2: While **Heating/Cooling + Hot water** mode (**Hot Water** priority) $T_{set} \geq THP_{max} + \Delta T_{hot\ water} + 2$, when water tank temperature reach THP_{max} , the water tank EH will be ON and start to do hot water, at the same time, the compressor will turn to heating/cooling mode, water tank EH and Compressor will be ON together.

3.2.4.18 Gate Control Memory

[Operation Instructions]

At the commissioning parameter setting page, by touching “Gate-Ctrl Memory”, it will access to the setting page.

[Notes]

- When it is enabled, “Gate-Ctrl” will be memorized upon power failure.
- When it is disabled, “Gate-Ctrl” will not be memorized upon power failure.

3.2.4.18 Parameter Setting

[Operation Instructions]

★At the commissioning parameter setting page, by touching “PARAM.”, it will access to the pages as shown below.

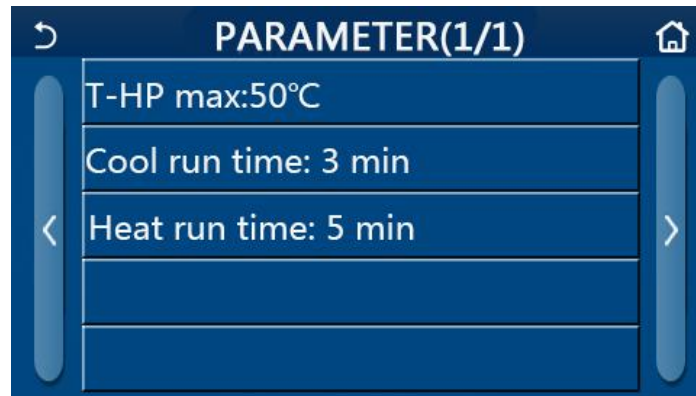

Page of Commissioning Parameters

★At this page, select the desired option and then go to the corresponding page.

★After that, by pressing “OK”, this setting will be saved and then the unit will run based on this setting; or by pressing “Cancel”, this setting will not be saved and quit.

No	Full Name	Display Name	Range		Default	Remark
1	T-HP max	T-HP max	40~55℃	104~131℉	50℃/122℉	
2	Cool run time	Cool run time	1~10min		3min [2-way valve Off]	When “Cool run time” has expired and temperature difference keeps at the standby zone, the unit will stop.
					5min [2-way valve On]	
3	Heat run time	Heat run time	1~10min		3min [2-way valve Off]	When “Heat run time” has expired and temperature difference keeps at the standby zone, the unit will stop.
					5min [2-way valve On]	

[Notes]

- For parameters with different defaults at different conditions, once the current condition changes, the corresponding default also will change.
- All parameters at this page will be memorized upon power failure.

3.2.5 Viewing

[Operation Instructions]

★1. At the menu page, by touching “VIEW”, the control panel will go to the sub-menu page as shown in

the figure below.



VIEW Page

3.2.5.1 Status Viewing

[Operation Instructions]

★1. At the "VIEW" page, by touching "Status", it is able to view status of the unit, as shown in the figure below.

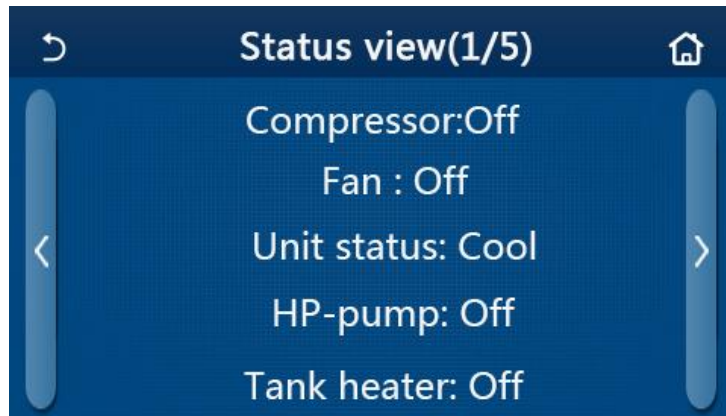

Status View Page

Viewable Status

No	Full Name	Displayed Name	Status
1	Status of the compressor	Compressor	On/Off
2	Status of the fan	Fan	On/Off
3	Status of the unit	Unit status	Cool/Heat/Hot water/Off
4	Status of the water pump	HP-pump	On/Off
5	Status of the water tank heater	Tank heater	On/Off
6	Status of the 3-way valve 1	3-way valve 1	NA
7	Status of the 3-way valve 2	3-way valve 2	On/Off
8	Status of the compressor crankcase heater	Crankc. heater	On/Off
9	Status of the heater 1 for the main unit	HP-heater 1	On/Off
10	Status of the heater 2 for the main unit	HP-heater 2	On/Off
11	Status of the Chassis heater	Chassis heater	On/Off
12	Status of the heat exchanger heater	Plate heater	On/Off
13	Status for the system defrosting	Defrost	On/Off
14	Status of the system oil return	Oil return	On/Off
15	Status of the thermostat	Thermostat	Off/Cool/Heat
16	Status of other thermal source	Other thermal	On/Off
17	Status of the 2-way valve	2-way valve	On/Off
18	Status of antifreeze	HP-Antifree	On/Off
19	Status of the door guard	Gate-Ctrl.	Card in/Card out
20	Status of the 4-way valve	4-way valve	On/Off
21	Status of disinfection	Disinfection	Off/Running/Done/Fail
22	Status of the flow switch	Flow switch	On/Off

3.2.5.2 Parameter Viewing

[Operation Instructions]

★1. At the “VIEW” page, by touching “Parameter”, it is able to view each parameter of the unit, as shown in the figure below.

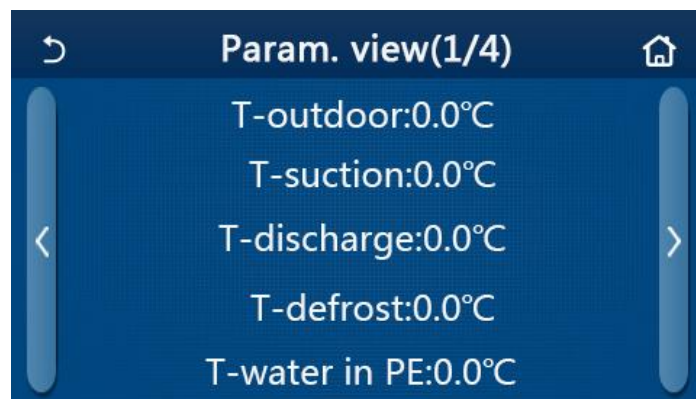

Parameter View Page
Viewable Parameters

No.	Full Name	Displayed Name
1	Environmental temperature	T-outdoor
2	Suction temperature	T-suction
3	Discharge temperature	T-discharge

4	Defrosting temperature	T-defrost
5	Entering water temperature of the plate type heat exchanger	T-water in PE
6	Leaving water temperature of the plate type heat exchanger	T-water out PE
7	Leaving water temperature of the auxiliary heater	T-optional water Sen.
8	Water tank temperature	T-tank ctrl.
9	Floor debug target temperature	T-floor debug
10	Floor debug runtime	Debug time
11	Liquid line temperature	T-liquid pipe
12	Vapor line temperature	T-gas pipe
13	Economizer inlet temperature	T-economizer in
14	Economizer outlet temperature	T-economizer out
15	Remote room temperature	T-remote room
16	Discharge pressure	Dis. pressure
17	Weather-dependent target temperature	T-weather depend

3.2.5.3 Error Viewing

[Operation Instructions]

★At the “VIEW” page, by touching “Error”, it is able to view errors of the unit, as shown in the figure below.



Error View Page

[Notes]

- The control panel can display real-time errors. And at these pages, all errors will be listed here.
- Each page displays at most 5 pieces of errors. Others can be viewed by touching the page turning keys.

Error List

No	Full Name	Displayed Name	Code
1	Ambient temperature sensor error	Ambient sensor	F4
2	Defrosting temperature sensor error	Defrost sensor	d6
3	Discharge temperature sensor error	Discharge sensor	F7
4	Suction temperature sensor error	Suction sensor	F5
5	Economizer inlet temperature sensor	Econ. in sens.	F2
6	Economizer outlet temperature sensor	Econ. out sens.	F6

Control

No	Full Name	Displayed Name	Code
7	Fan error	Outdoor fan	EF
8	High pressure protection	High pressure	E1
9	Low pressure protection	Low pressure	E3
10	High discharge protection	Hi-discharge	E4
11	Capacity DIP switch error	Capacity DIP	c5
12	Communication error between the outdoor and indoor main boards	ODU-IDU Com.	E6
13	Communication error between the outdoor main board and the drive board	Drive-main com.	P6
14	Communication error between the display panel and indoor main board	IDU Com.	E6
15	High pressure sensor error	HI-pre. sens.	Fc
16	Leaving water temperature sensor error for the plate type heat exchanger of the heat pump	Temp-HELW	F9
17	Leaving water temperature sensor error for the auxiliary electric heat of the heat pump	Temp-AHLW	dH
18	Entering water temperature sensor error of the plate type heat exchanger of the heat pump	Temp-HEEW	No error code but displayed at the error view pages.
19	Water tank temperature sensor error	HI-pre. sens.	FE
20	Remote room temperature sensor error	T-Remote Air	F3
21	Protection for the flow switch of the heat pump	HP-Water Switch	Ec
22	Welding protection to the auxiliary electric heater 1 of the heat pump	Auxi. heater 1	EH
23	Welding protection to the auxiliary electric heater 2 of the heat pump	Auxi. heater 2	EH
24	Welding protection to the water tank electric heater	Auxi. -WTH	EH
25	DC bus under-voltage or voltage drop error	DC under-vol.	PL
26	DC bus over-voltage	DC over-vol.	PH
27	AC current protection (input side)	AC curr. pro.	PA
28	IPM defective	IPM defective	H5
29	PFC defective	PFC defective	Hc
30	Start failure	Start failure	Lc
31	Phase loss	Phase loss	Ld

No	Full Name	Displayed Name	Code
32	Communication error with the drive board	Driver Com.	P6
33	Driver resetting	Driver reset	P0
34	Compressor overcurrent	Com. over-cur.	P5
35	Overspeed	Overspeed	LF
36	Current sensing circuit error or current sensor error	Current sen.	Pc
37	Desynchronization	Desynchronize	H7
38	Compressor stalling	Comp. stalling	LE
39	Radiator or IPM or PFC over-temperature	Overtemp.-mod.	P8
40	Radiator or IPM or PFC temperature sensor error	T-mod. sensor	P7
41	Charging circuit error	Charge circuit	Pu
42	AC input voltage error	AC voltage	PP
43	Ambient temperature sensor error at the drive board	Temp-driver	PF
44	AC contactor protection or input over-zero error	AC contactor	P9
45	Temperature drift protection	Temp. drift	PE
46	Sensor connection protection (the current sensor fails to be connected with the corresponding phase U and or phase V)	Sensor con.	Pd
47	Communication error between the display panel and the outdoor unit	ODU Com.	E6
48	Refrigerant vapor line temperature sensor error	Temp RGL	F0
49	Refrigerant liquid line temperature sensor error	Temp RLL	F1
50	4-way valve error	4-way valve	U7

3.2.5.4 Error Log

[Operation Instructions]

★ At the “**VIEW**” page, by touching “**Error log**”, the control panel will go to the error log page, where it is able to view error records.

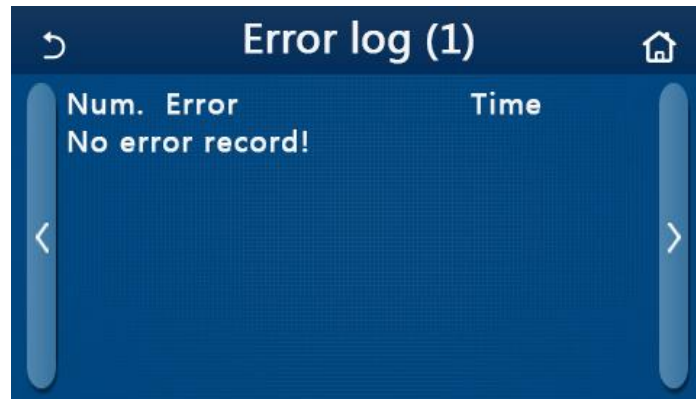

[Notes]:

- The error log can accommodate up to 20 pieces of error. Name and occurrence time are available for each error.
- When error log exceeds 20, the latest will supersede the earliest.

3.2.5.5 Version Viewing

[Operation Instructions]

- ★ At the “**VIEW**” page, by touching “**Version**”, the control panel will go to the version view page, where it is able to view both the program version and protocol version.



3.2.6 General Setting

[Operation Instructions]

- ★1. At the menu page, by touching “**GENERAL**”, the control panel will go to the setting page, as shown in the figure below, where it is able to set “**Temp.unit**”, “**On/off memory**”, “**Beeper**”, “**Back light**”, “**Time & Date**” and “**Language**”.

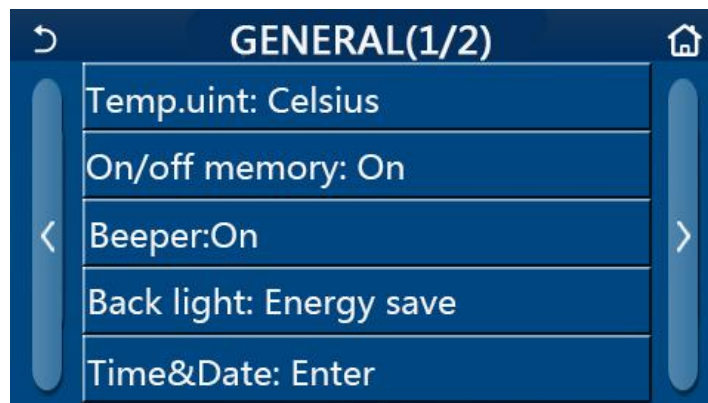

General Setting Page

General Settings

No	Item	Range	Default	Remarks
1	Temp. unit	°C/°F	°C	/
2	On/Off memory	On/Off	On	/
3	Beeper	Enter	On	/
4	Back light	Lighted/Energy save	Energy save	<p>“Lighted”: the control panel will always light on.</p> <p>“Energy save”: When there is no touching operation in 5 minutes, the control panel will be lighted off automatically, but will light on again once there is any touching operation.</p>
5	Time&Data	Enter	/	/
6	Language	Italian/English/Spanish	English	/
7	WiFi	On/Off	On	/

3.2.6.1 Clock Setting

[Operation Instructions]

- ★ 1. At the **“GENERAL”** setting page, by touching **“Time&Data”**, it will go to the setting page as shown in the figure below.

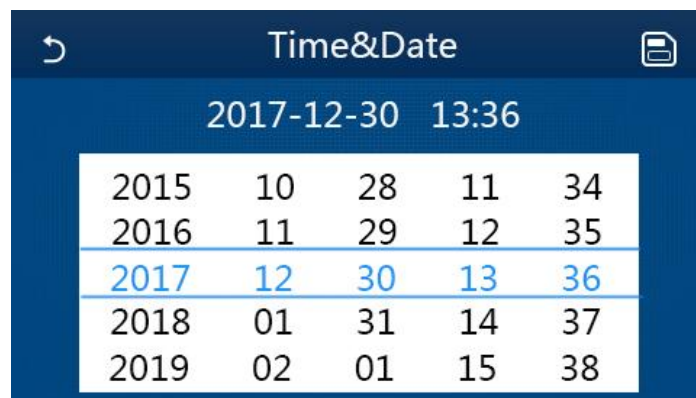

Time&Date Page

- ★ 2. The mouse roller can change the date and time value. After it, by touching the **“Save”** icon, this setting will be saved and directly displayed; while by touching the **“Back”** icon, this setting will give up and the control panel will directly go back to the **“GENERAL”** setting page.

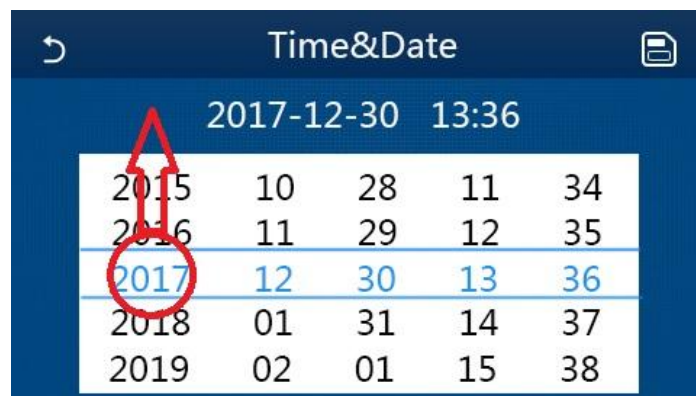

Time&Date Page

3.3 Intelligent Control

[Notes]:

- Make sure the smart phone or tablet computer adopts standard Android or ios operation system. For detailed version, please refer to the APP.
- The Wi-Fi function doesn't support Chinese Wi-Fi network name.
- The devices can be connected and controlled only in Wi-Fi and 4G hotspot modes.
- Router with WEP encryption is not supported.
- Software operation interface is universal and its control functions may not be completely corresponding to the unit. Software operation interface may vary along with APP upgrading or different operation system. Please refer to the actual program.

3.3.1 Installation of the Ewpe Smart APP

[Operation Instructions]

- ★ 1. Scan the following QR code with your smart phone to download and install Ewpe Smart APP directly.

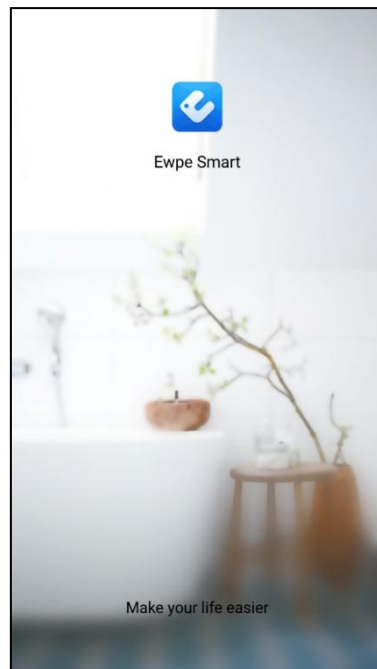

★ 2. Open Ewpe Smart APP and click “Sign up” for registration.

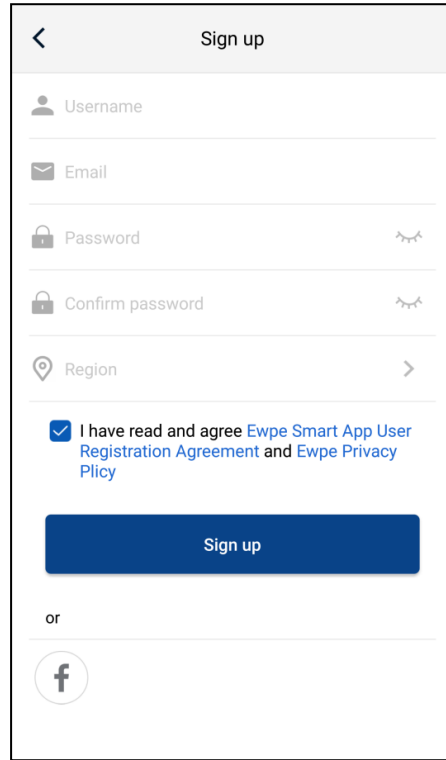
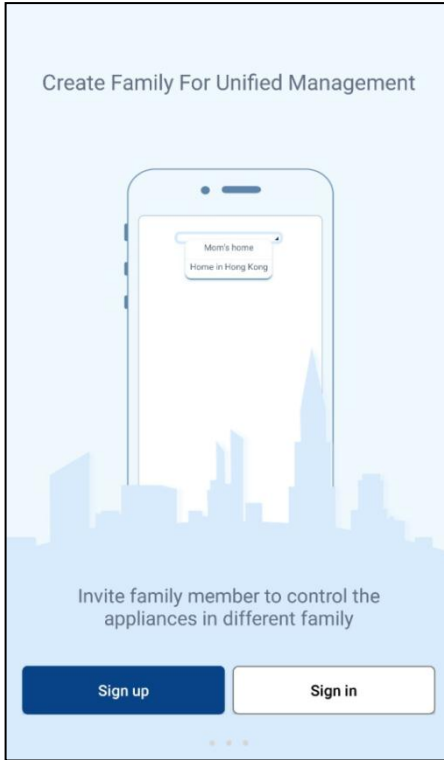

- ★ 3. Except sign in in the prompt interface, you can also enter the homepage and click the profile picture at the left upper corner to sign in.

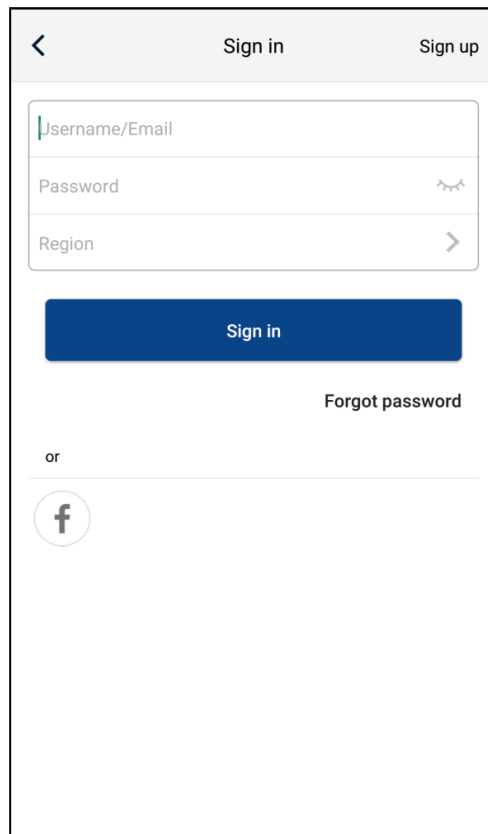
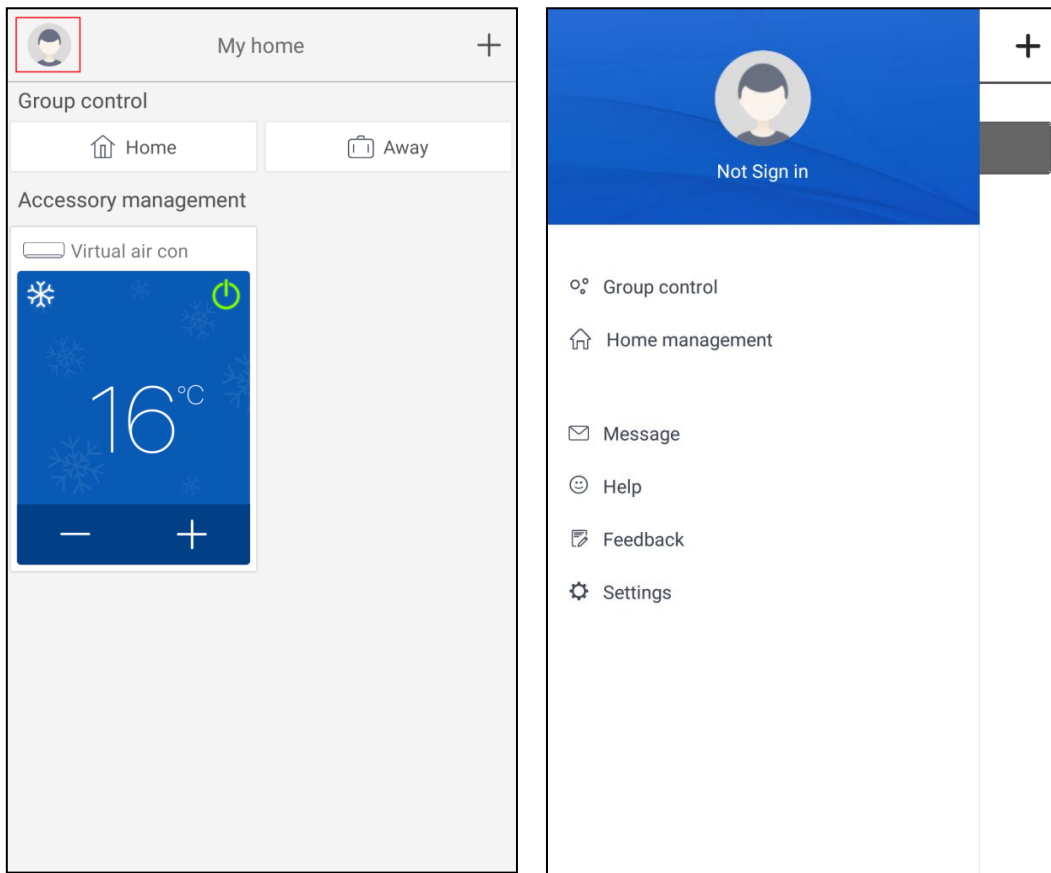

Control

- ★ 4. Click "+" at the right upper corner of homepage to add device.

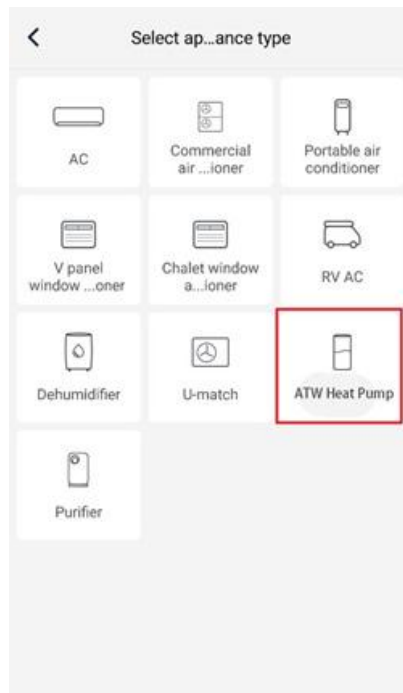
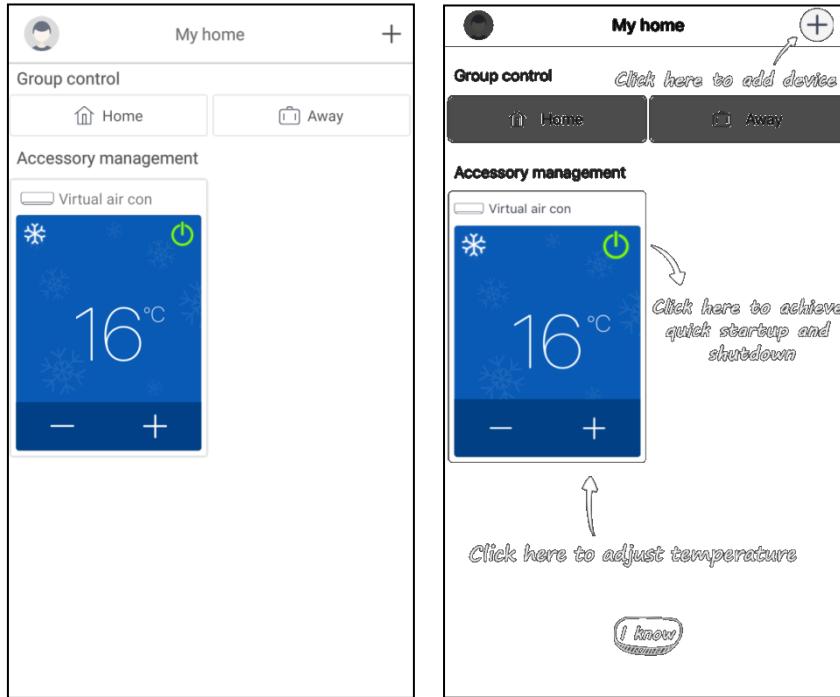

After selecting “ATW Heat Pump”, the APP interface will provide relevant operation instructions.

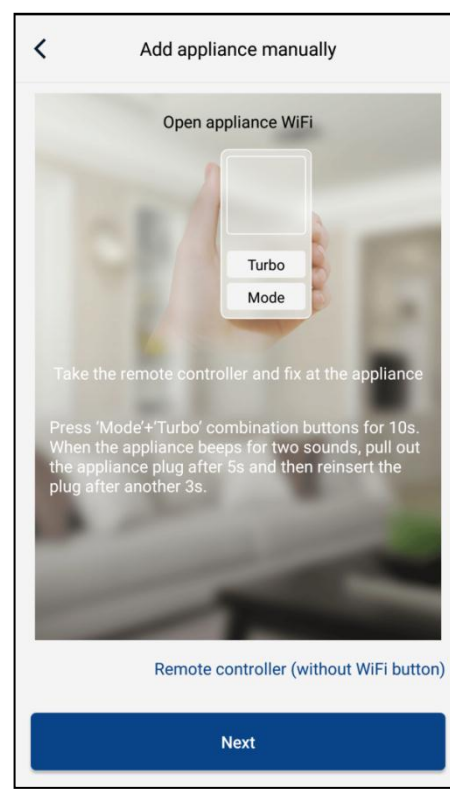
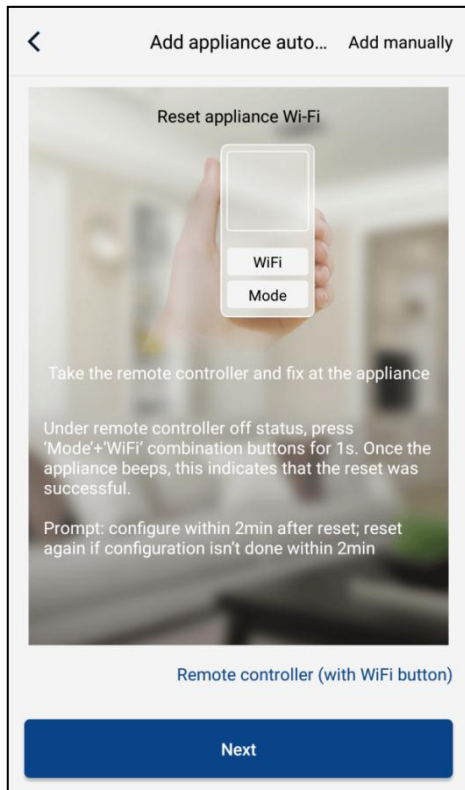
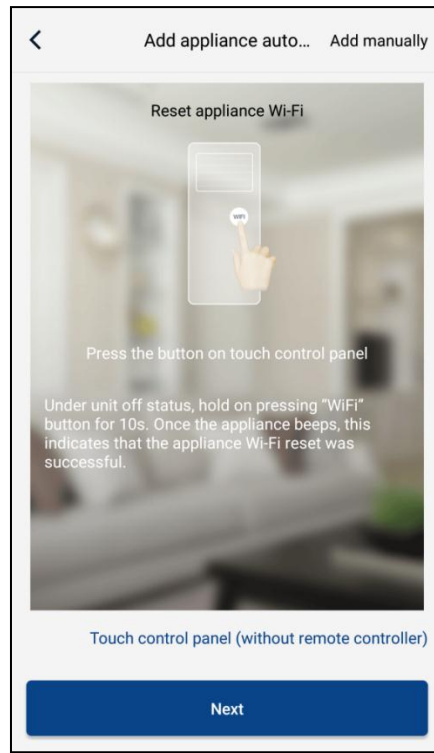
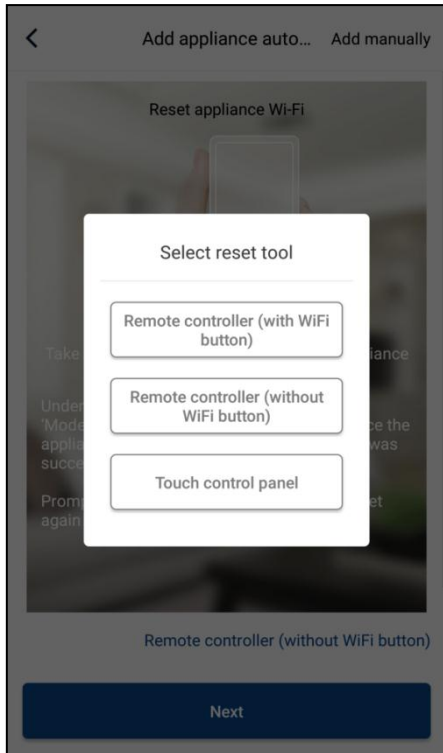

Reset the air conditioner (refer to the operation instructions in APP interface) and click “Next” to add home appliance automatically (Wi-Fi password shall be input). Or after setting and energizing the air conditioner, click “Add appliance manually” at the right upper corner to select the wireless network for controlling the device. Then confirm family Wi-Fi and arrange configuration.

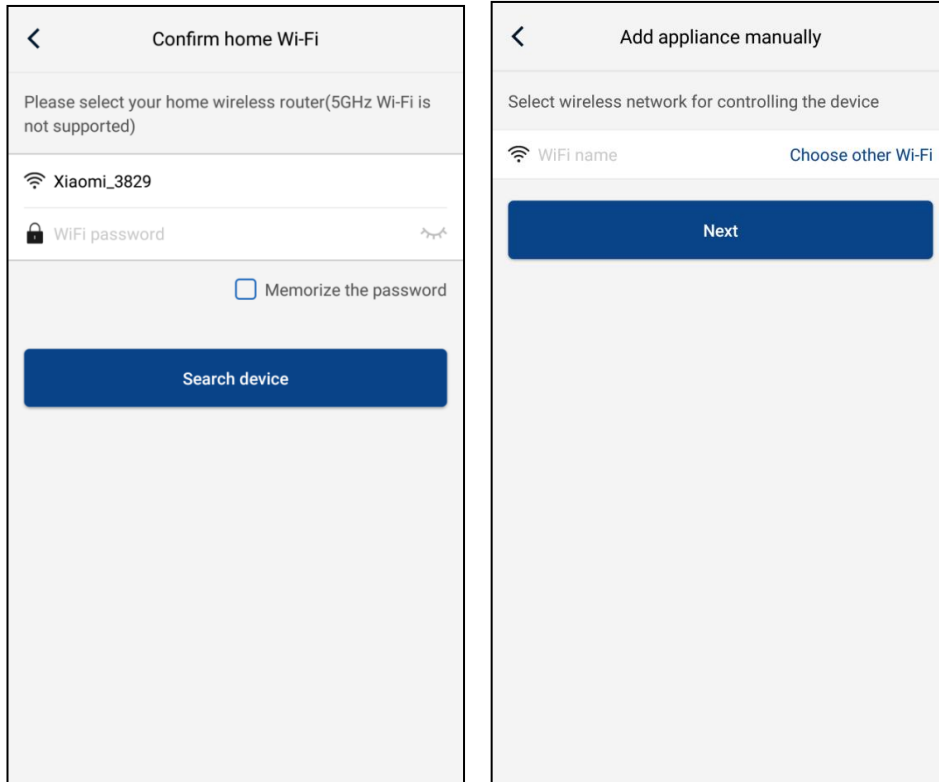

After accomplishing device reset and filling correct information, search device and arrange configuration.

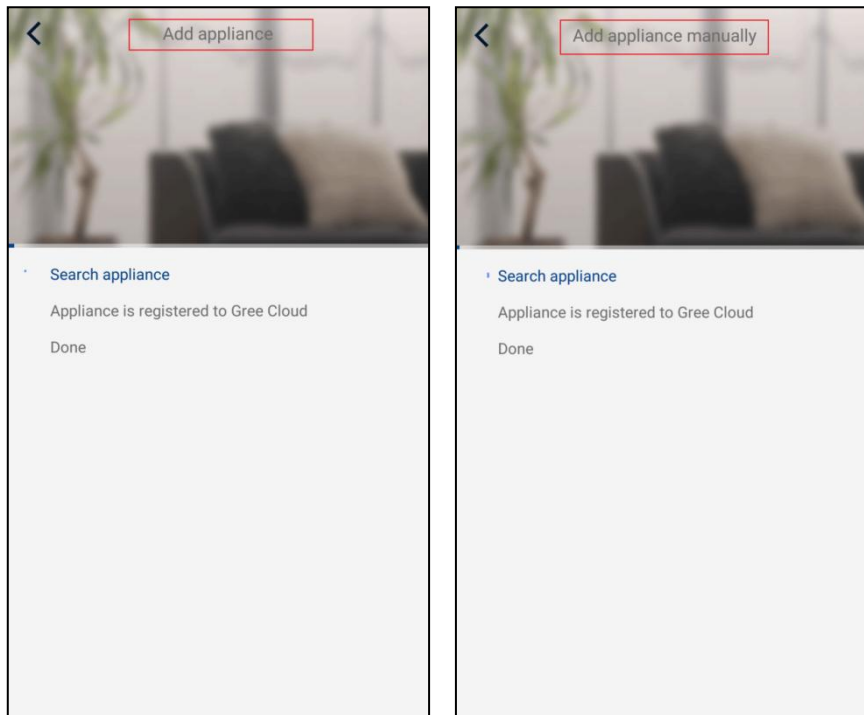

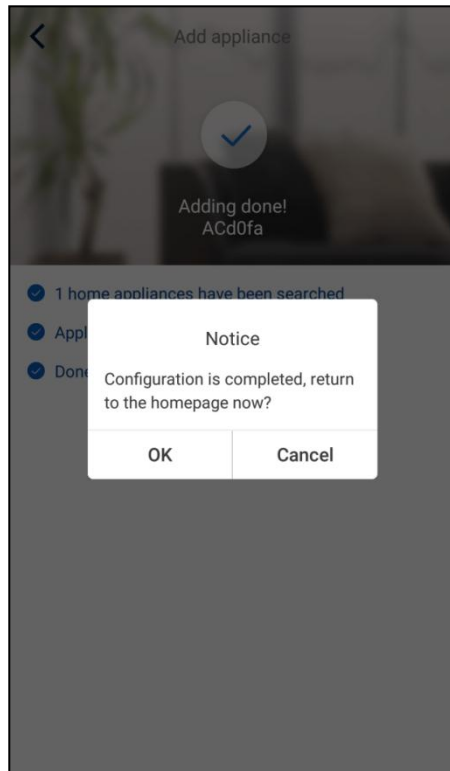

3.3.2 Setting of Main Functions

- ★ 1. Set mode and temperature.

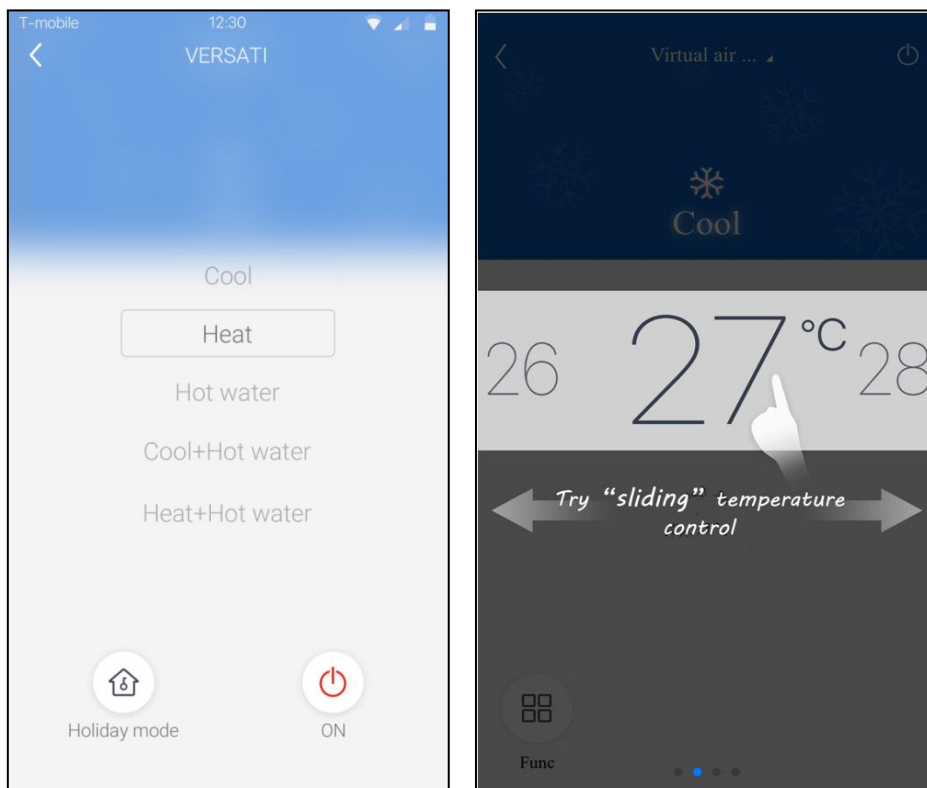

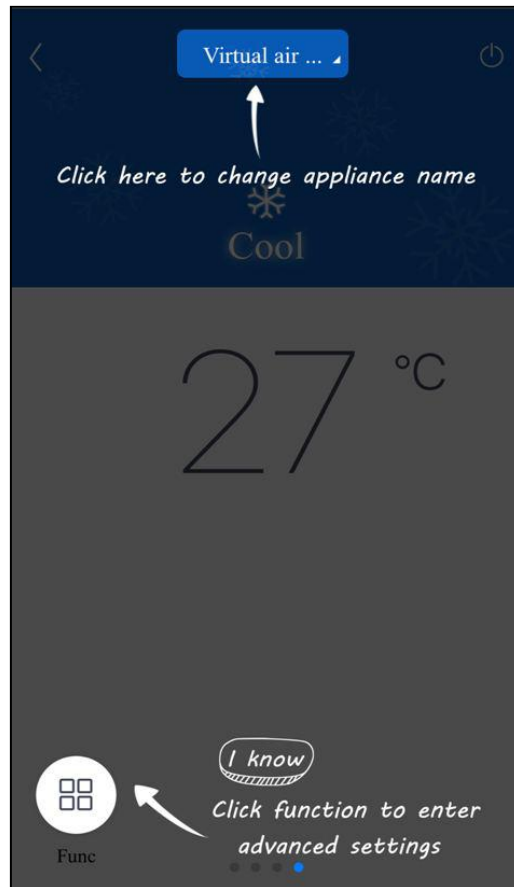

★2. Click Func at the left lower corner in device operation interface to enter advanced settings

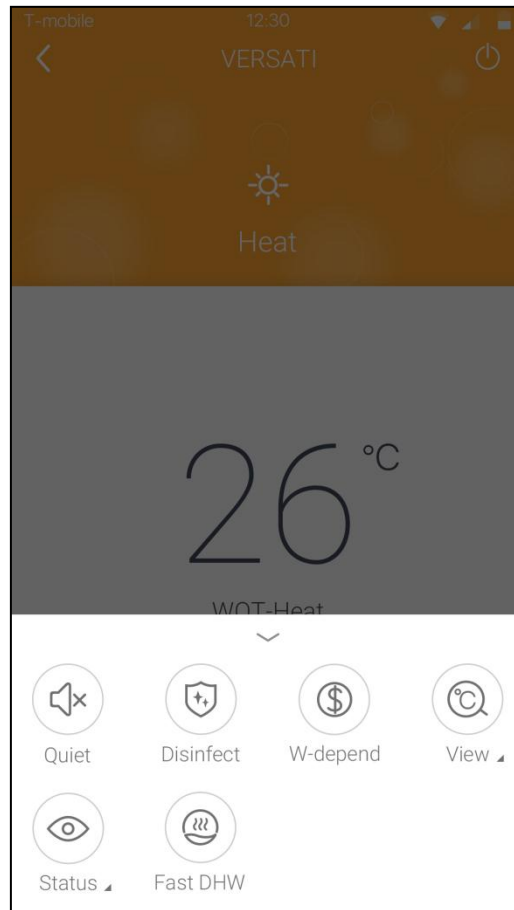

3.3.3 Setting of Other Functions

Click the profile picture at the left upper corner of homepage and set each function in the following menu.

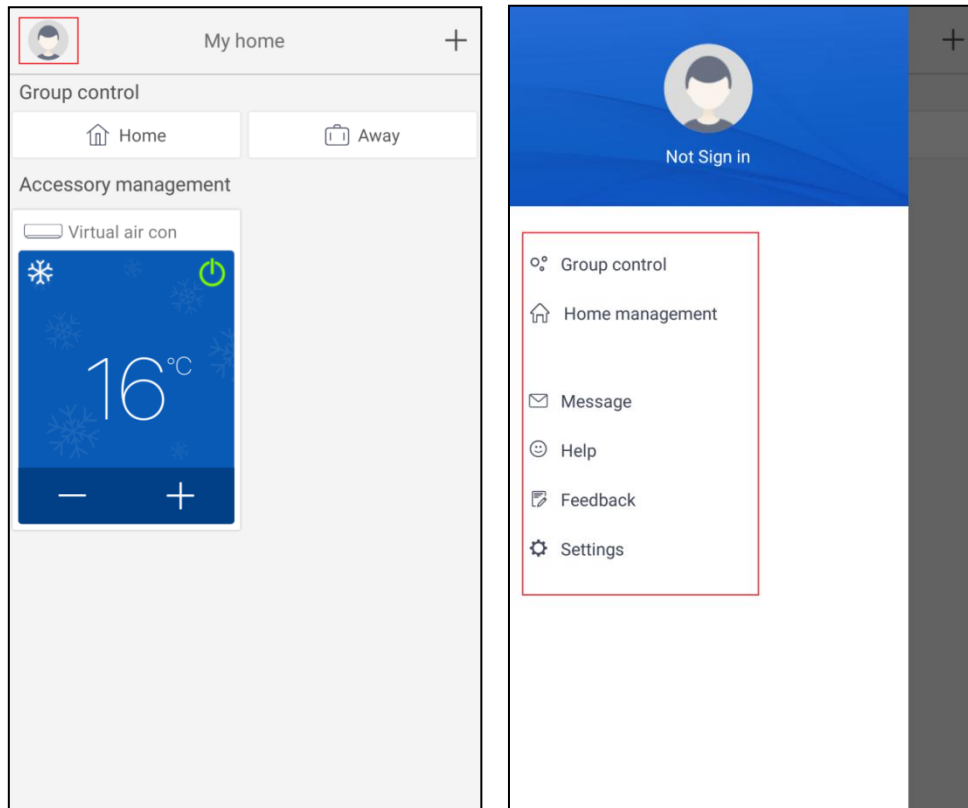

3.3.3.1 Home management

Click "Home management" to create or manage family. You can also add family members according to the registered account.

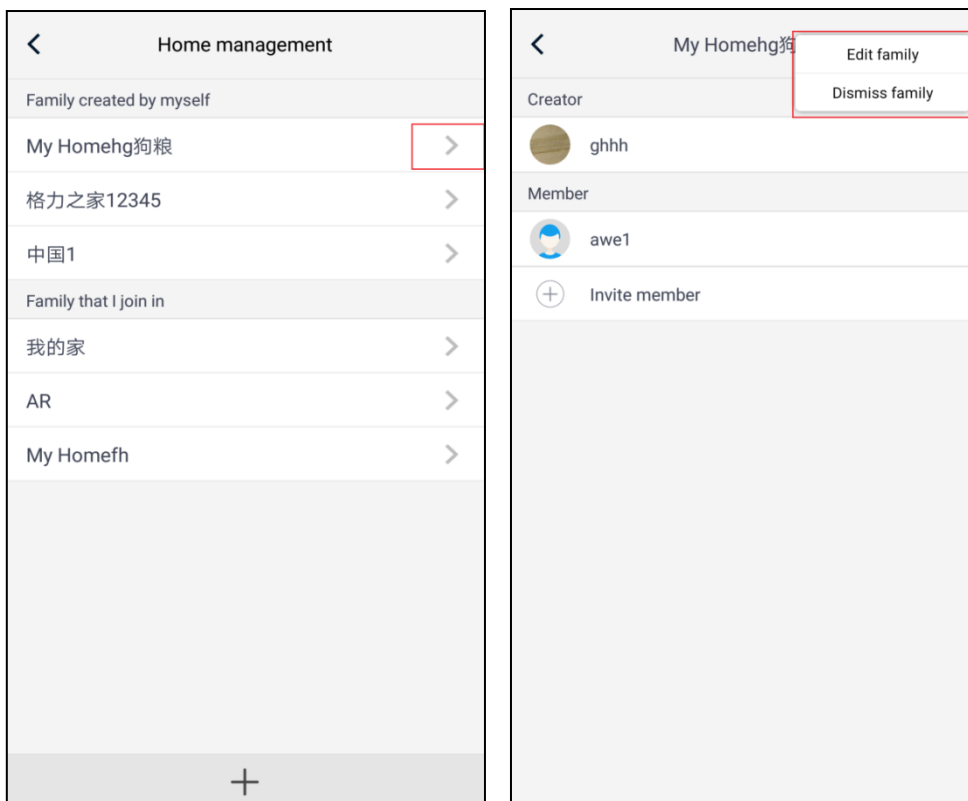

Control

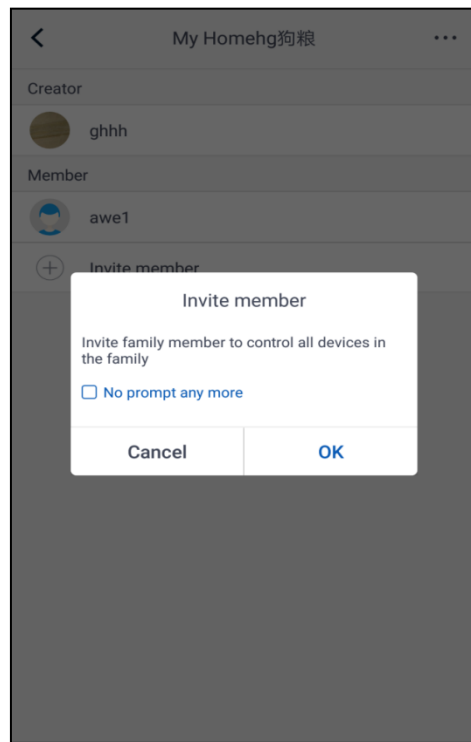
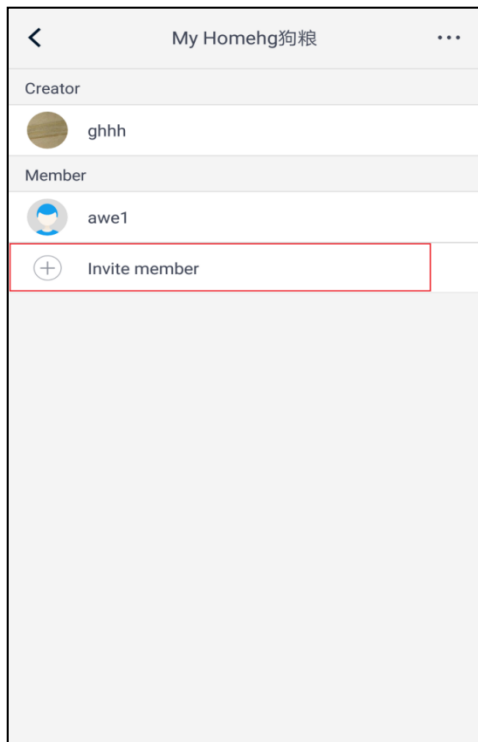

3.3.3.2 Help

Click "Help" and view the operation instructions of the APP.

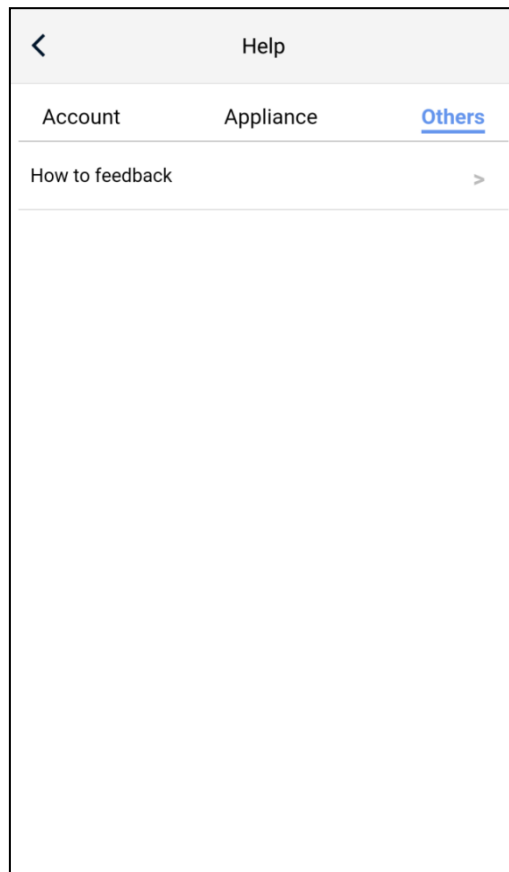
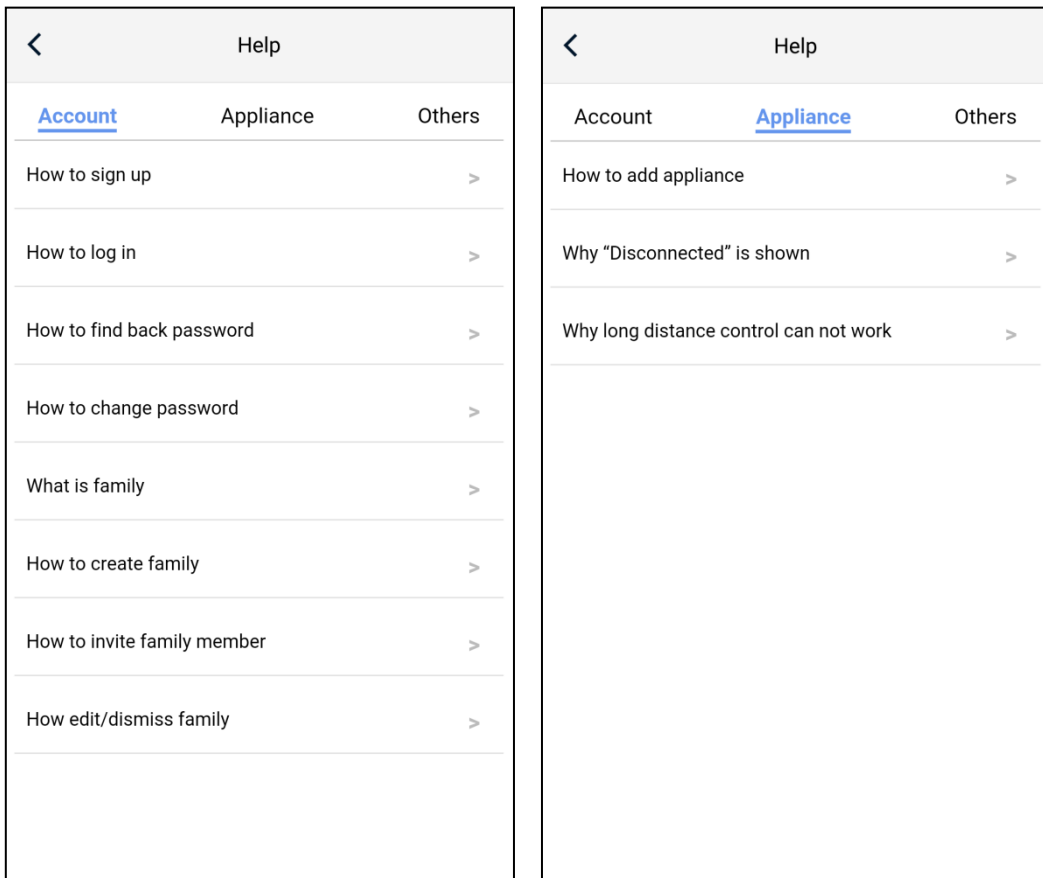

3.3.3.3 Feedback

Click "Feedback" to submit feedback.

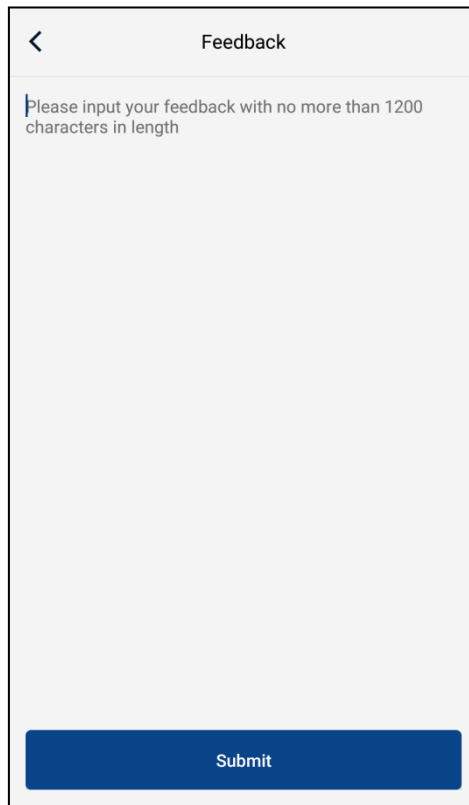

A screenshot of a mobile application's feedback form. The form has a light gray background and a dark blue header bar with a back arrow on the left and the word "Feedback" in the center. Below the header, there is a text input field with a blue cursor. The text "Please input your feedback with no more than 1200 characters in length" is displayed above the input field. At the bottom of the form, there is a dark blue button with the word "Submit" in white text.

UNIT INSTALLATION

1. Installation Guides

WARNING!

- (1) Installation should be performed by Sinclair appointed servicemen, or improper installation would lead to unusual operation, water leakage, electric shock or fire hazard.
- (2) The unit should be installed on the foundation which is capable of supporting the unit, or the unit would fall off or even lead to personal injury.
- (3) All electric installation should be done by electrician in accordance with local laws and regulations, as well as the User's Manual and this Service Manual. Besides, the special power lines should be used, as any improper line would lead to electric shock or fire hazard.
- (4) All electric lines should be safe and secured reliably. Be sure the terminal board and electric lines will not be affected by any external force, or it would lead to fire hazard.
- (5) The electric lines should run properly to make the cover of the electric box secured tightly, or it would cause the terminal board overheated or cause electric shock or fire hazard.
- (6) Cut off the power supply before touching any electric element.

CAUTION!

- (1) The unit should be grounded properly and the ground line is not allowed to connect with the gas line, water line, lightning rod or phone line.
- (2) The breaker should be installed, or it would lead to electric shock.
- (3) The drain pipe should be installed in accordance with the User's Manual and this Service Manual to ensure free drainage, and the drain pipe should be insulated against condensation. Once the drain pipe is installed improperly, it would lead to water leak which then will damps the ceiling and furniture.
- (4) Do not place the unit where there is oil fog, like kitchen, or the plastic would be aged, broken off or the polluted evaporator would lead to water leak and poor performance.
- (5) Do not place the unit where there is corrosive gas (like sulfur dioxide), or the corroded copper tubes or welded joint would lead to refrigerant leakage.
- (6) Do not place the unit where there is inflammable gas, carbon fiber, inflammable dust or volatile combustible, as they would lead to fire hazard.

SAFETY!

- (1) Always use safety outfits at the construction site.
- (2) No smoking and no drunken operation are allowed at the construction site.
- (3) Wear no gloves and tighten the cuff when operating the machinery and electrical equipment. Do not maintain it during operation.
- (4) Use the abrasive-disk cutter and stand at the side of the rotating abrasive disk.
- (5) Clean the opening when installing the riser pipe, and then cover it tightly. Do not throw down any material.
- (6) The use of the electric and gas welders should be approved firstly. Once used, a fire distinguisher should be prepared and a service man should be there always. There should be no inflammable and explosive substances around the welding site.
- (7) A platform should be set up when working high above the ground.







1.1 Installation Position

- (1) Avoid direct sunshine.
- (2) Must be installed on a firm and solid support.
- (3) Ensure the hanger rod, ceiling and building structure have sufficient strength to support the weight of air conditioner unit.
- (4) Avoid placing the unit under window or between two constructions, hence to prevent normal operating noise from entering the room.
- (5) Air flow at inlet and outlet shall not be blocked.
- (6) Install at a well-ventilated place, so that the machine can absorb and discharge sufficient air.
- (7) Do not install at a place where inflammable or explosive goods exist or a place subject to severe dust, salty fog and polluted air.
- (8) Drainage pipe is easy to connect out.
- (9) Do not install at a place where inflammable or explosive goods exist or inflammable or explosive gas might leak.
- (10) Do not install at a place subject to corrosive gas, severe dust, salty fog, smoke or heavy moisture.





1.2 Matters Need Attention

- (1) The installation of unit must be in accordance with national and local safety codes.
- (2) Installation quality will directly affect the normal use of air conditioner unit. The user is prohibited from installation by himself. Please contact your dealer after buying this machine. Professional installation workers will provide installation and test services according to installation manual.
- (3) Do not connect to power until all installation work is completed.

2 Filed Supplied Pipes and Valves

Name	Picture	Usage
Water Filter		It is used to remove foreign matters in the waterway.
2-way Valve		It is used to switch waterways between underfloor system and the FCU.
3-way Valve		It is used to switch waterways of hot water inside the water tank and circulation water inside the main unit.
Bypass Valve		It is used to balance the water pressure.
Water Trap		It is used to distribute water.
Pipe and Pipe Joint		It is used to connect the water pipes.
Cut-off Valve		It is used to cut off or get through the waterway.

3 Service Tools

Name	Picture
Spanner	
Screw Driver	
Pliers	
Tube Tongs	

4 Instalaltion Instructions

4.1 Installation Examples

CASE 1: Connecting Under-floor Coil for Heating and Cooling

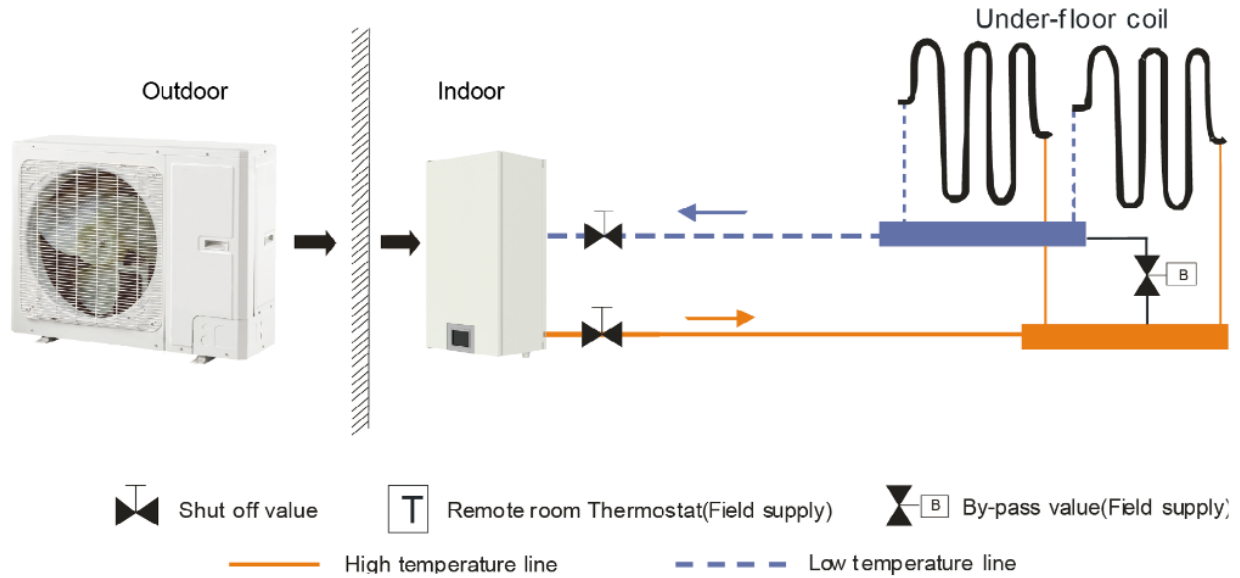

Notes:

- (1) The two-way valve is very important to prevent dew condensation on the floor and radiator while cooling mode;
- (2) Type of thermostat and specification should be complied with installation of this manual;
- (3) The bypass valve must be installed to secure enough water flow rate, and should be installed at the collector.

CASE 2: Connecting Sanitary Water Tank and under floor coil

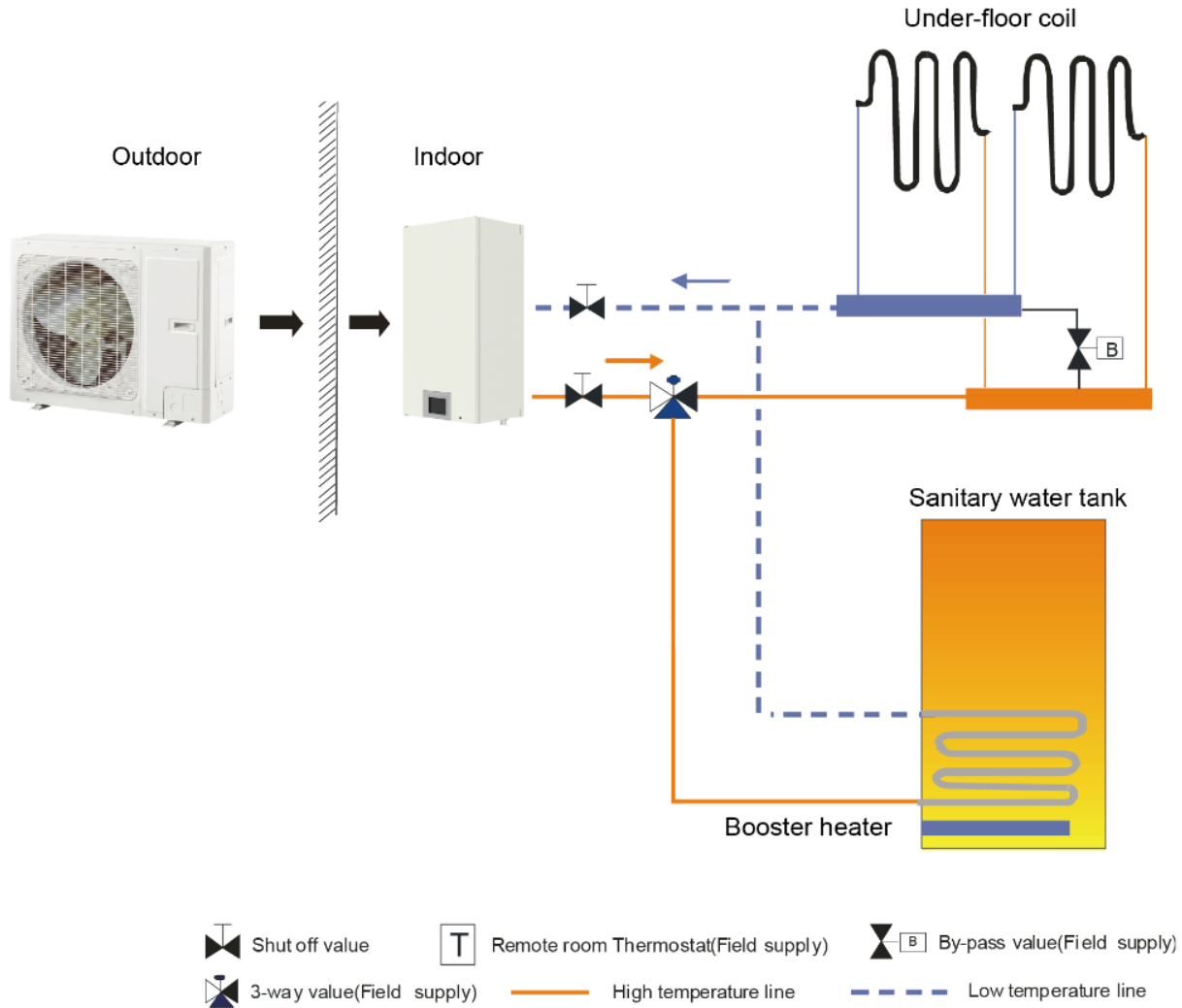

Notes:

- (1) In this case, three-way valve should be installed and should be complied with installation of this manual;
- (2) Sanitary water tank should be equipped with internal electric heater to secure enough heat energy in the very cold days.

CASE 3: Connecting Sanitary Water Tank, Under-floor Coil and FCU

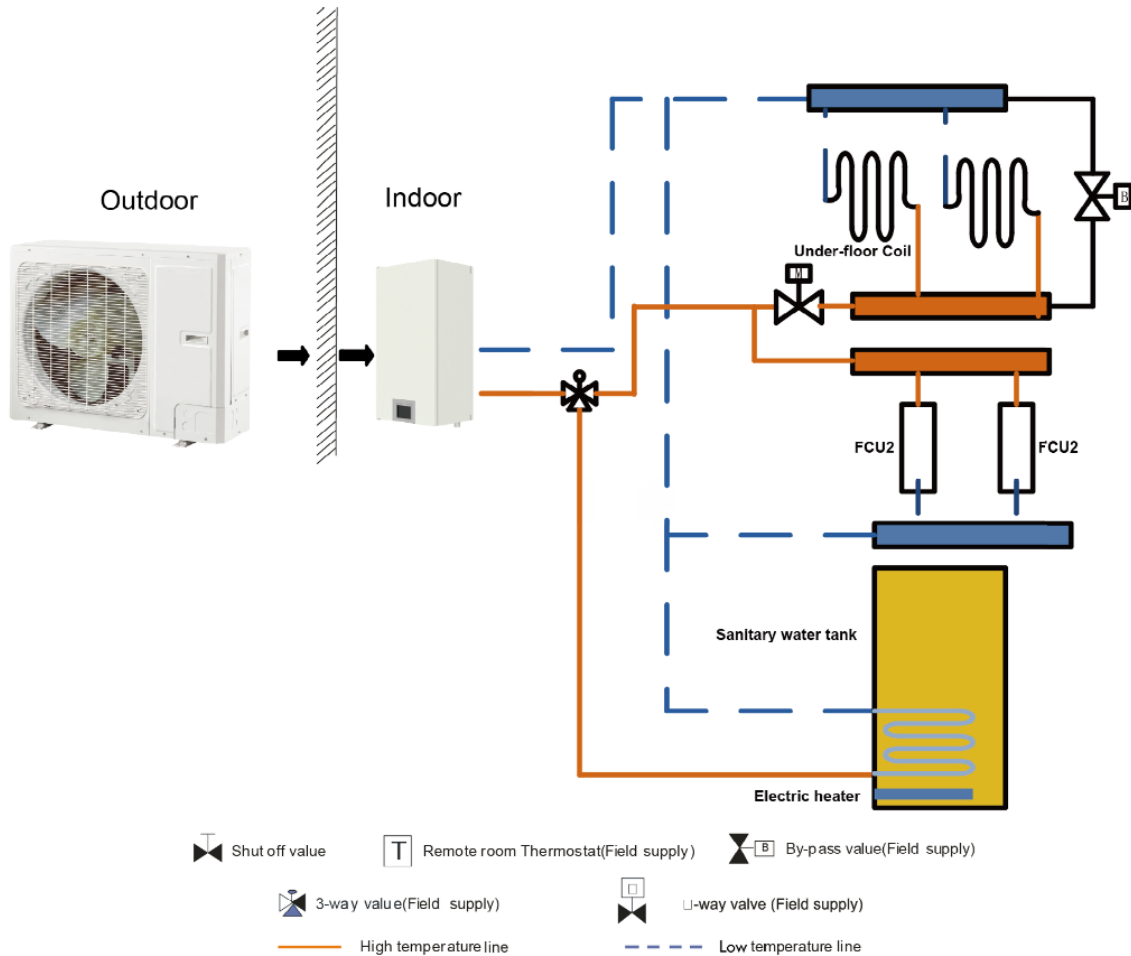

Notes

- (1) The two-way valve is very important to prevent dew condensation on the floor and FCU while cooling mode
- (2) In this case, three-way valve should be installed and should be complied with installation of this manual;
- (3) Sanitary water tank should be equipped with internal electric heater to secure enough heat energy in the very cold days.
- (4) (d) When the FCU and the underfloor coil are used at the same time, performance of the underfloor coil is satisfied firstly. When performance of the FCU is required, then “Floor config” should be set to “Without” .

4.2 Pre-Installation

- (1) Installation of the unit must be in accordance with national and local safety codes.
- (2) Installation quality will directly affect the normal use of the air conditioner unit. The user is prohibited from installation by himself. Please contact your dealer after buying this machine. Professional installation workers will provide installation and test services according to the installation manual.
- (3) Do not connect to power supply until all installation work is completed.

4.3 Selection of Installation Location

- (1) The outdoor unit must be installed on a firm and solid support.
- (2) Avoid placing the outdoor unit under window or between two constructions, hence to prevent normal operating noise from entering the room.
- (3) Air flow at inlet and outlet shall not be blocked.
- (4) Install at a well-ventilated place, so that the machine can absorb and discharge sufficient air.
- (5) Do not install at a place where inflammable or explosive goods exist or a place subject to severe dust, salty fog and polluted air.

4.4 Outline Dimension of Outdoor Unit

- ◆ GSH-80ERB, GSH-100ERB

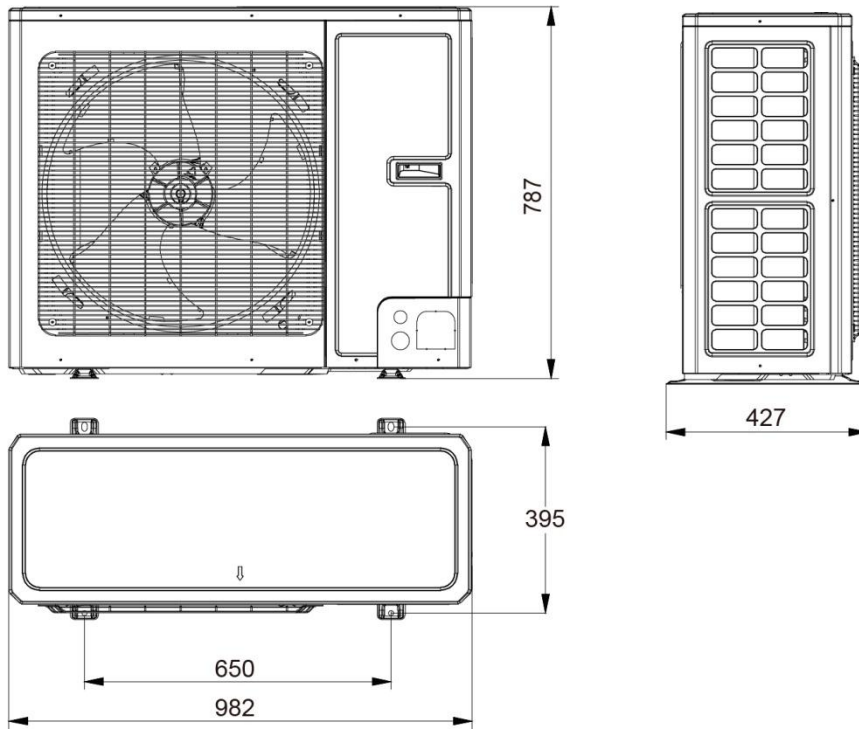

◆ GSH-80IRB, GSH-100IRB

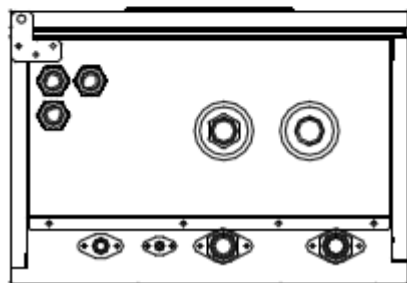
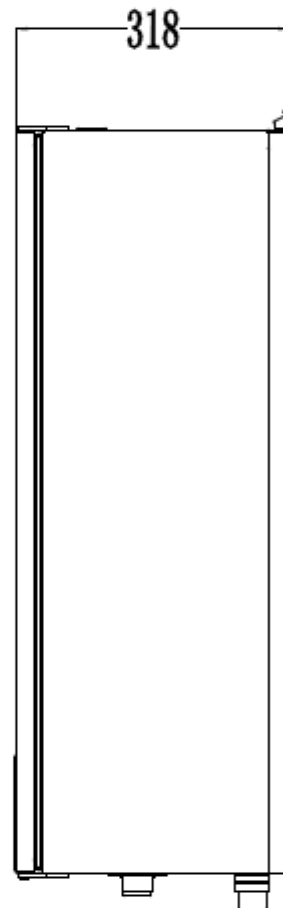
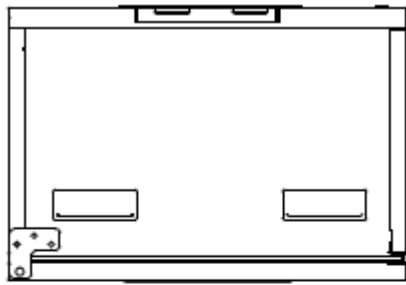

4.5 Installation of Outdoor Unit

4.5.1 Instruction to installation

- (1) Installation of the unit must be in accordance with national and local safety codes.
- (2) Installation quality will directly affect the normal use of the air conditioner unit. The user is prohibited from installation. Please contact your dealer after buying this machine. Professional installation workers will provide installation and test services according to installation manual.
- (3) Do not connect to power until all installation work is completed.

4.5.2 Installation of outdoor unit

6.2.1 Select installation location of outdoor unit

- (1) Outdoor unit must be installed on a firm and solid support.
- (2) Outdoor unit shall be installed close to the indoor unit, hence to minimize the length and bends of cooling pipe.
- (3) Avoid placing the outdoor unit under window or between two constructions, hence to prevent normal operating noise from entering the room.
- (4) Air flow at inlet and outlet shall not be blocked.
- (5) Install at a well-ventilated place, so that the machine can absorb and discharge sufficient air.
- (6) Do not install at a place where flammable or explosive goods exist or a place subject to severe dust, salty fog and polluted air.

4.5.3 Outline dimension of outdoor unit

GSH-80ERB, GSH-100ERB

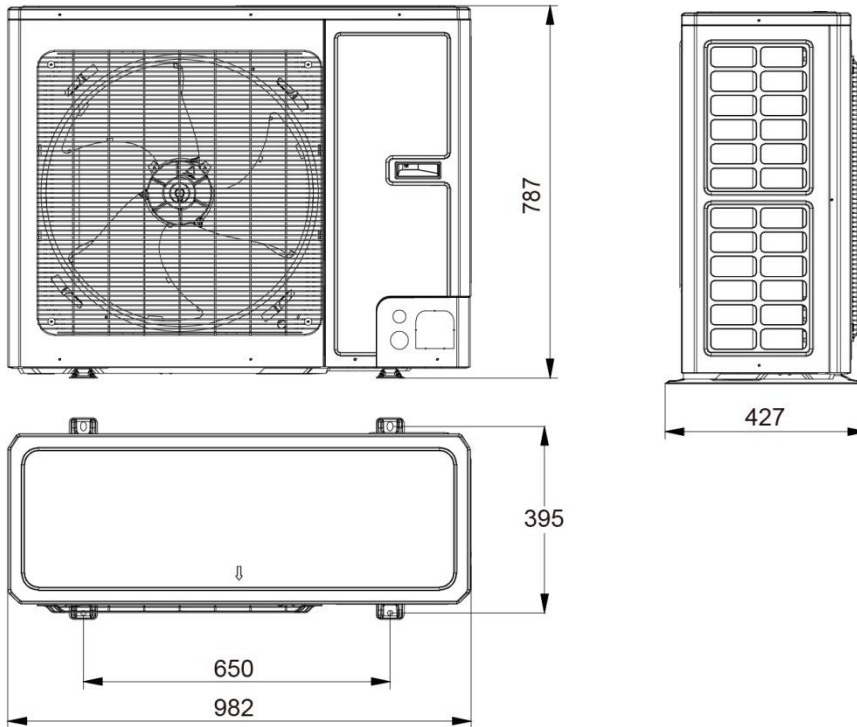

Description:

No	Name	Remarks	
1	Liquid-side Service Valve	1/4	GSH-80IRB/ERB, GSH-100IRB/ERB
2	Gas-side Service Valve	1/2	
3	Handle	Used to cover or uncover the front casew	
4	Air discharge Grill	/	

4.5.4 Space requirements for installation

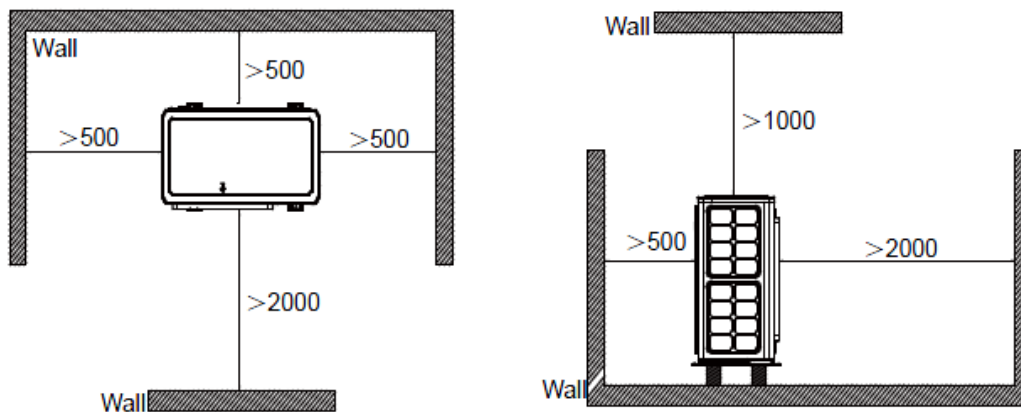

4.5.5 Precautions on installation of outdoor unit

- (1) When moving outdoor unit, it is necessary to adopt 2 pieces of long enough rope to hand the unit from 4 directions. Included angle between the rope when hanging and moving must be 40 ° below to prevent center of the unit from moving.
- (2) Adopt M12 bolts components to tighten feet and under frame when installing.
- (3) Outdoor unit should be installed on concrete base that is 10cm height.
- (4) Requirements on installation space dimension of unit's bodies are shown in following drawing.

(5) Outdoor unit must be lifted by using designated lifting hole. Take care to protect the unit during lift. To avoid rusting, do not knock the metal parts.

(6) Note:When release and refix the screw of the clasper,should use your hand to support the panel.And then,after connected power cable,please ensure using the elastic trip of accessory to tighten with the pipe.

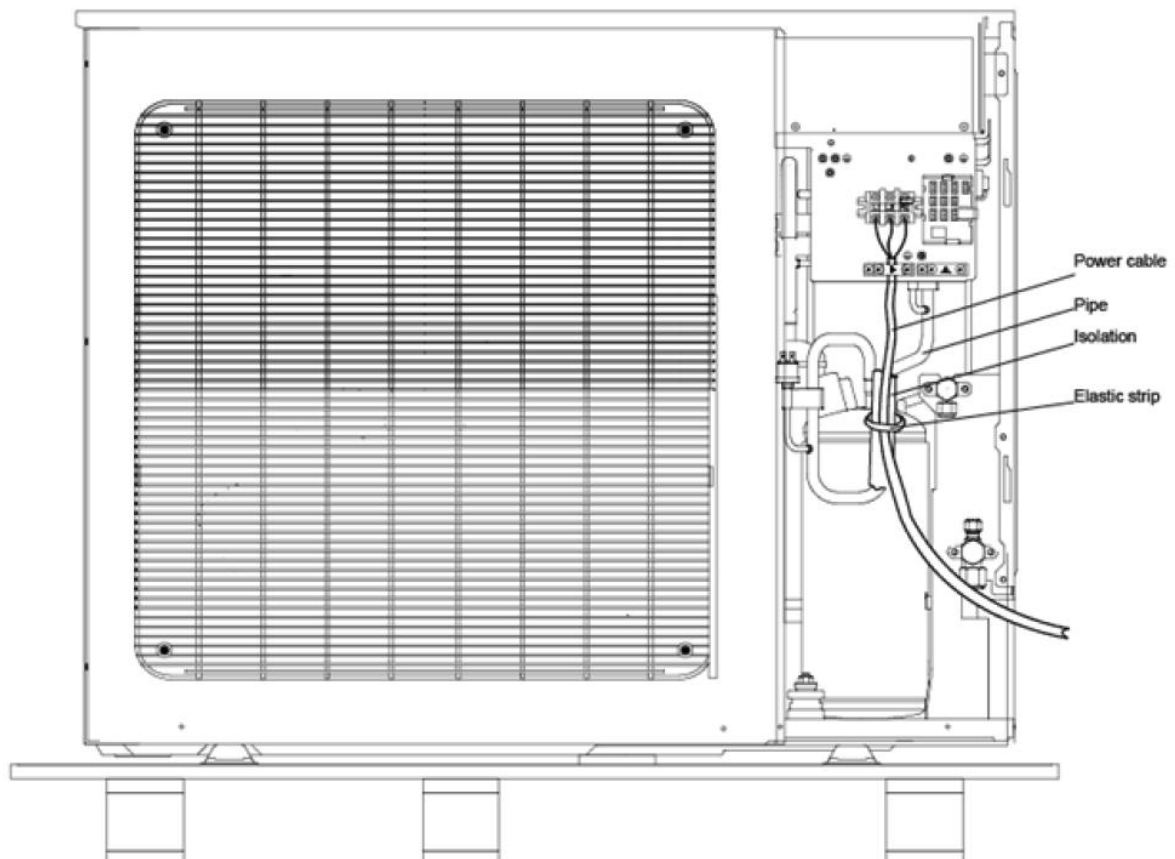

4.5.6 Safety operation of flammable refrigerant

(1) Qualification requirement for installation and maintenance of Hydraulic Unit

All the work men who are engaging in the refrigeration system should bear the valid certification awarded by the authoritative organization and the qualification for dealing with the refrigeration system recognized by this industry.

If it needs other technician to maintain and repair the appliance, they should be supervised by the person who bears the qualification for using the flammable refrigerant. It can only be repaired by the method suggested by the equipment’s manufacturer.

(2) Installation notes

The unit is not allowed to use in a room that has running fire (such as firesource, working coal gas ware, operating heater).

It is not allowed to drill hole or burn the connection pipe.

The unit must be installed in a room that is larger than the minimum room area. The minimum room area is shown on the nameplate or following table a.

Leak test is a must after installation.

Minimum room area (m ²)	Charge amount(kg)	≤1.2	1.3	1.4	1.5	1.6	1.7	1.8	1.9	2	2.1	2.2	2.3	2.4	2.5
	floor location	/	14.5	16.8	19.3	22	24.8	27.8	31	34.3	37.8	41.5	45.4	49.4	53.6
window mounted	/	5.2	6.1	7	7.9	8.9	10	11.2	12.4	13.6	15	16.3	17.8	19.3	
wall mounted	/	1.6	1.9	2.1	2.4	2.8	3.1	3.4	3.8	4.2	4.6	5	5.5	6	
ceiling mounted	/	1.1	1.3	1.4	1.6	1.8	2.1	2.3	2.6	2.8	3.1	3.4	3.7	4	

(3) Maintenance notes

Check whether the maintenance area or the room area meet the requirement.

- It’s only allowed to be operated in the rooms that meet the requirement.

Check whether the maintenance area is well-ventilated.

- The continuous ventilation status should be kept during the operation process.

Check whether there is fire source or potential fire source in th e maintenance area.

- The naked flame is prohibited in the maintenance area; and the “no smoking” warning board should be hanged.

Check whether the appliance mark is in good condition.

- Replace the vague or damaged warning mark.

(4) Welding

If you should cut or weld the refrigerant system pipes in the process of maintaining, please follow the steps as below:

- Shut down the unit and cut power supply
- Eliminate the refrigerant
- Vacuuming
- Clean it with N2 gas
- Cutting or welding
- Carry back to the service spot for welding

The refrigerant should be recycled into the specialized storage tank.

Make sure that there isn’t any naked flame near the outlet of th e vacuum pump and it’s well-ventilated.

(5) Filling the refrigerant

Use the refrigerant filling appliances specialized for R32. Make sure that different kinds of refrigerant won’t contaminate with each other.

The refrigerant tank should be kept upright at the time of filling refrigerant.

Stick the label on the system after filling is finished (or haven't finished).

Don't overfilling.

After filling is finished, please do the leakage detection before test running; another time of leak detection should be done when it's removed.

(6) Safety instructions for transportation and storage

Please use the flammable gas detector to check before unload and open the container.

No fire source and smoking.

According to the local rules and laws.

4.6 Installation of Indoor Unit

4.6.1 Select installation location of indoor unit

7.1 Select installation location of indoor unit

- (1) Avoid direct sunshine.
- (2) Ensure the hanger rod, ceiling and building structure have sufficient strength to support the weight of air conditioner unit.
- (3) Drainage pipe is easy to connect out.
- (4) Indoor and outdoor connection pipes are easy to go outdoors.
- (5) Do not install at a place where inflammable or explosive goods exist or inflammable or explosive gas might leak.
- (6) Do not install at a place subject to corrosive gas, severe dust, salty fog, smoke or heavy moisture.

4.6.2 Space requirements for installation

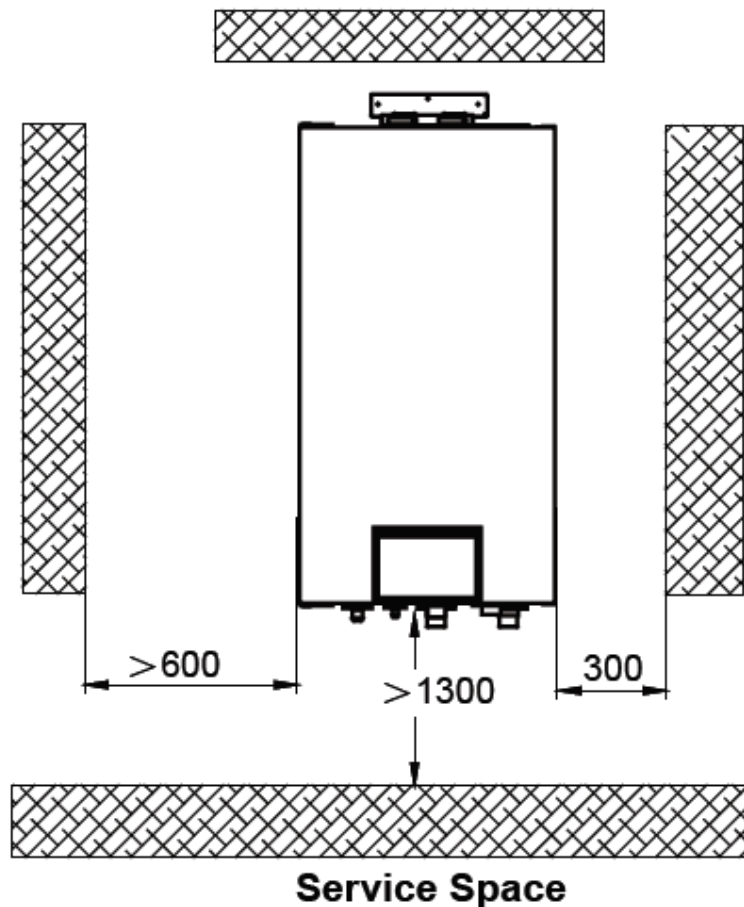

4.6.3 Install process of indoor unit

Step1:Drilling hole on the wall in the following draw.

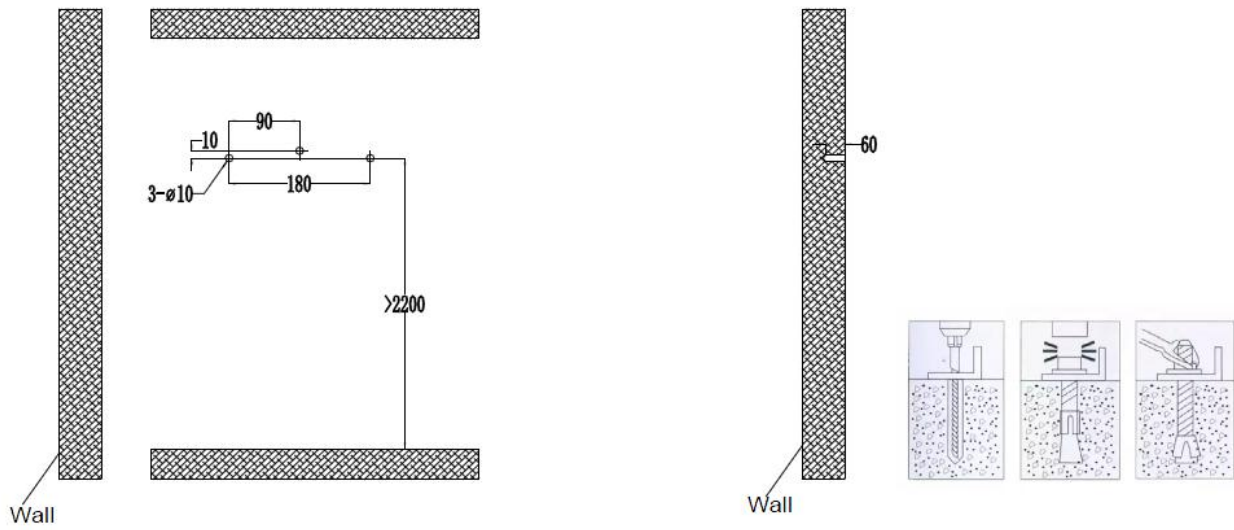

Step2: Install expansion bolts and forecasted panel.

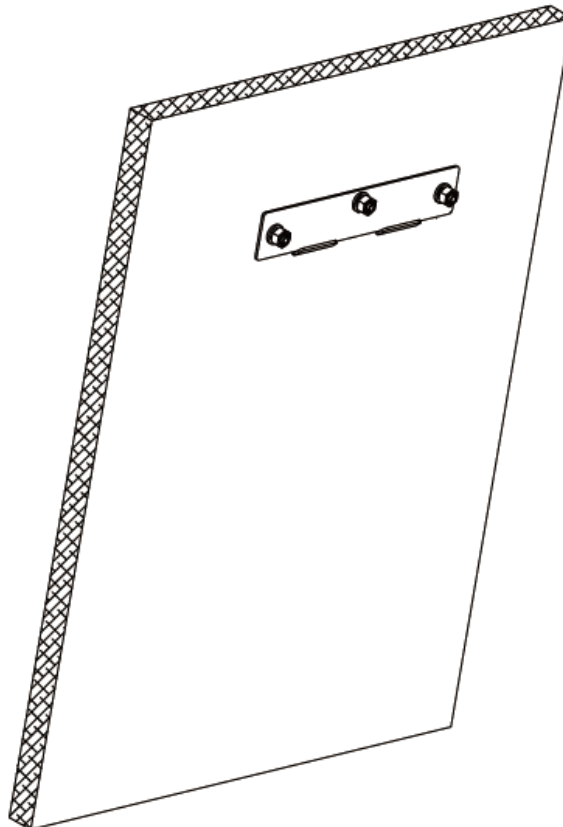

Step3: Attaching indoor unit to the wall.

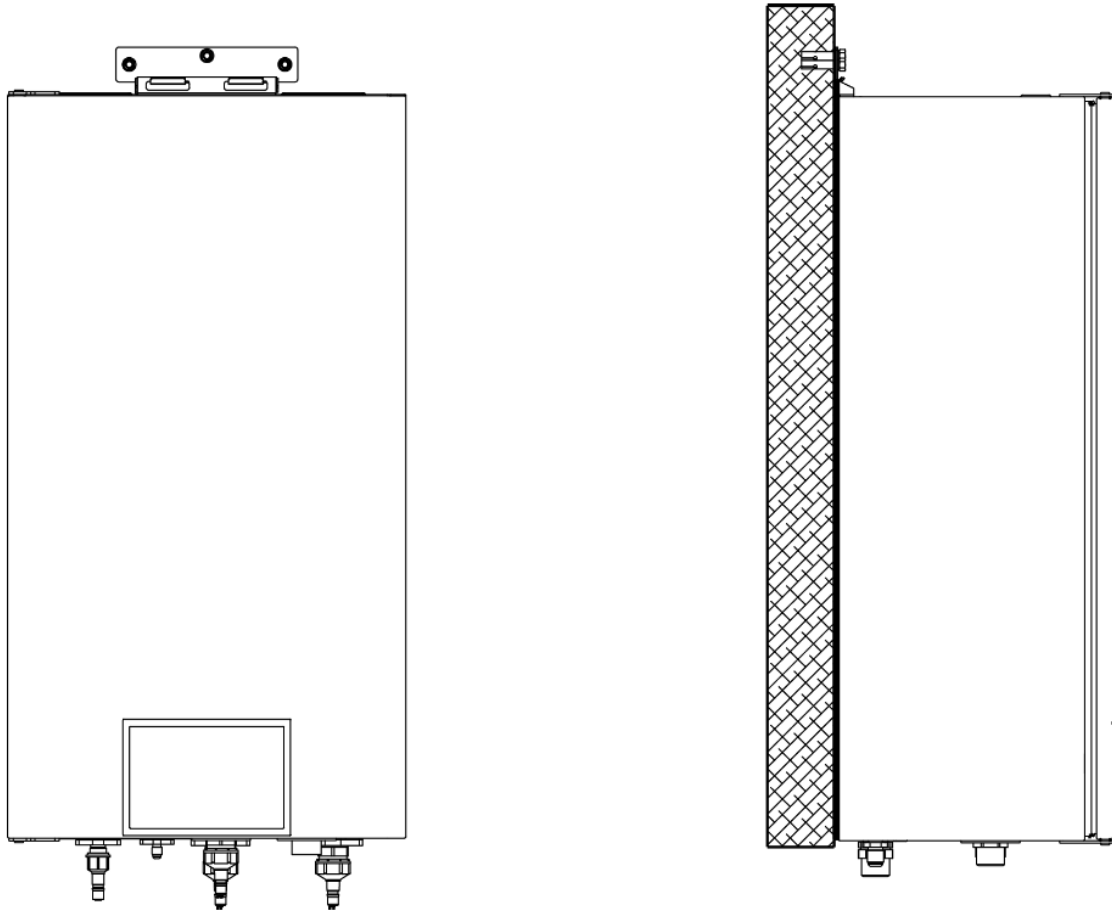

Note:

- While lifting the indoor unit, at least two persons should be joined. Weight of the indoor unit is more than 50kg.
- The indoor unit must be installed vertically to the ground and fastened securely.
- Before commissioning, the dust-proof cap of the automatic relief valve must be loosened, other than entirely being removed away, and it can be tightened in case that it leaks.

4.6.4 Outline dimension of indoor unit

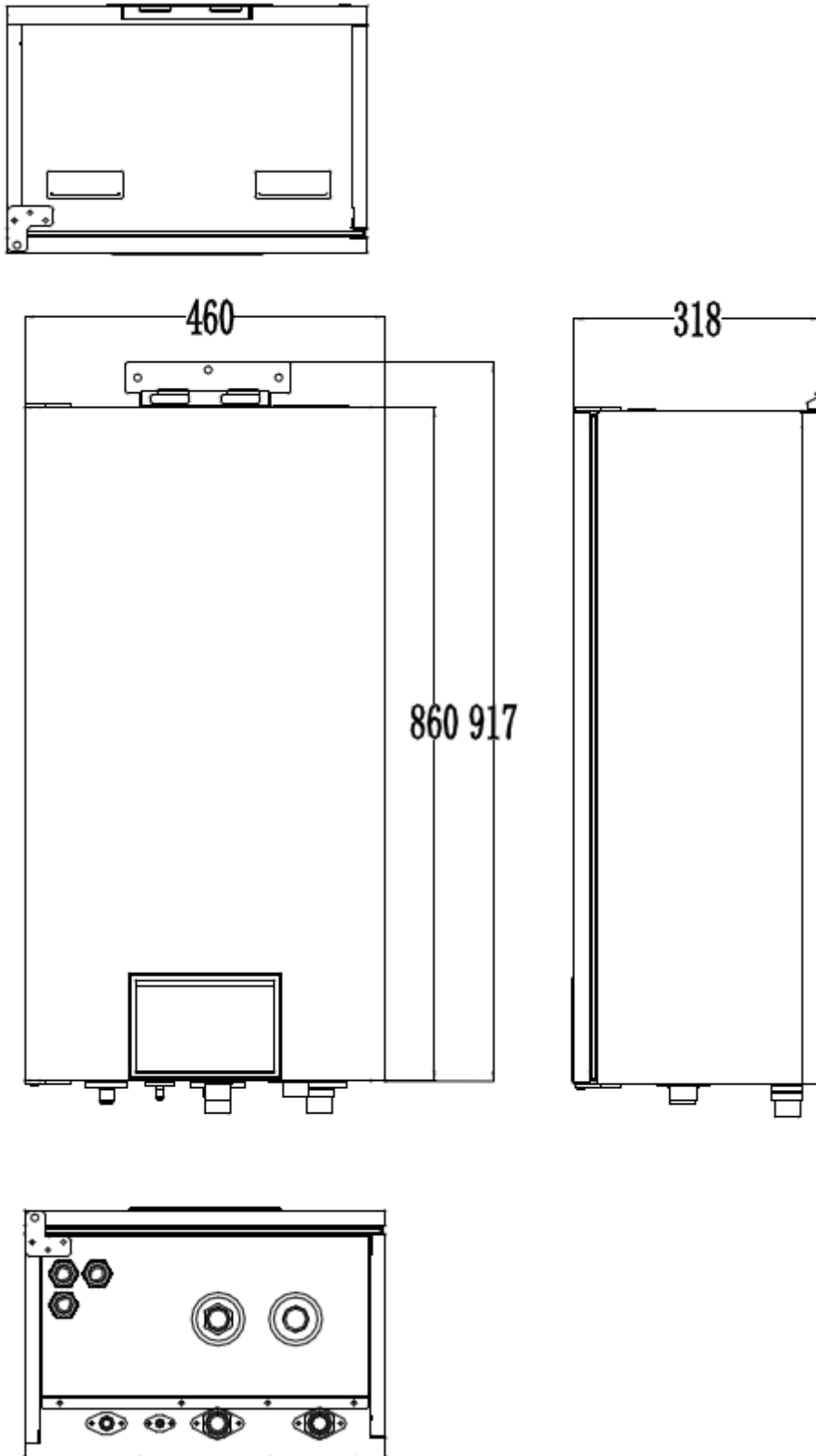

Description:

Unit: inch

No.	Name	Remarks	
1	Leaving Water Pipe	1"Male BSP	
2	Returning Water Pipe	1"Male BSP	
3	Gas-side Pipe	1/2	
4	Liquid-side Pipe	1/4	

4.6.5 Precautions on installation of indoor unit

- (1) Indoor unit shall be vertically mounted on the wall of the room with expansion bolt.
- (2) Keep the indoor unit away from heat sources like heat sink and so on in the room as much as possible.
- (3) Keep the indoor unit as close as possible to outdoor unit. Level distance between connection pipes cannot exceed 25m (8.0~10kW) and vertical distance cannot exceed 15m

4.6.6 Available External Static Pressure of Outlet

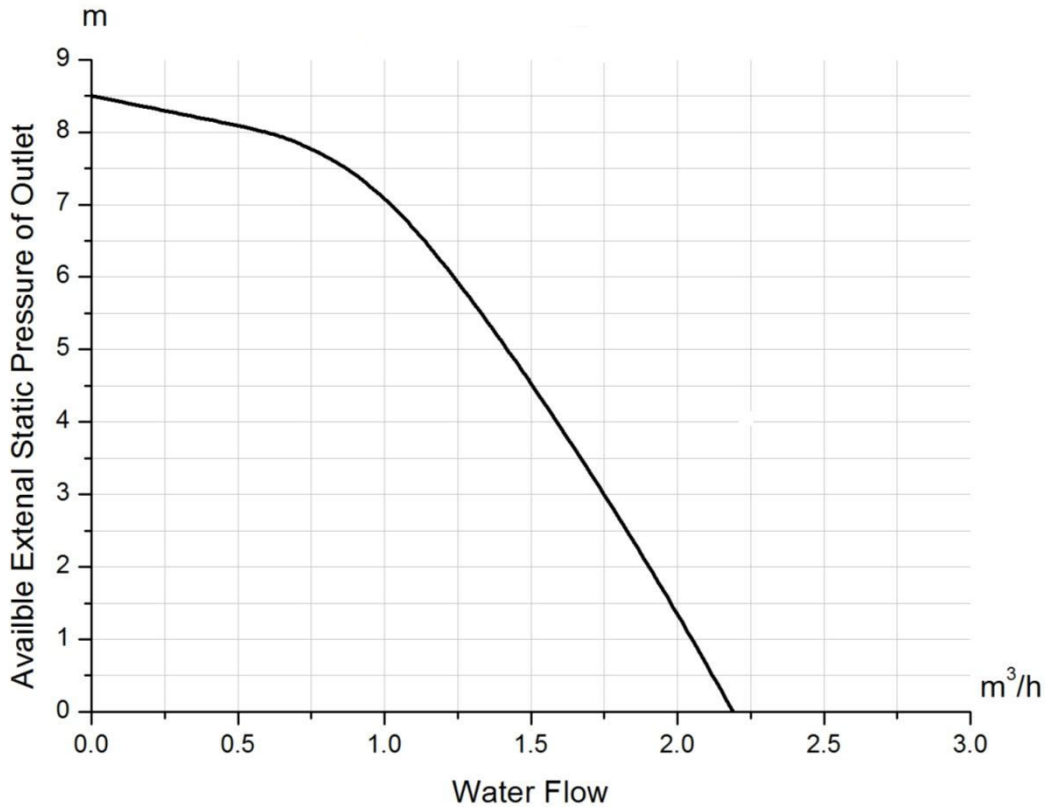

Note

See the curve above for the maximum external static pressure. The water pump is of variable frequency. And during operation, the water pump will adjust its output based on the actual load.

4.6.7 Water volume and expansion vessel pressure

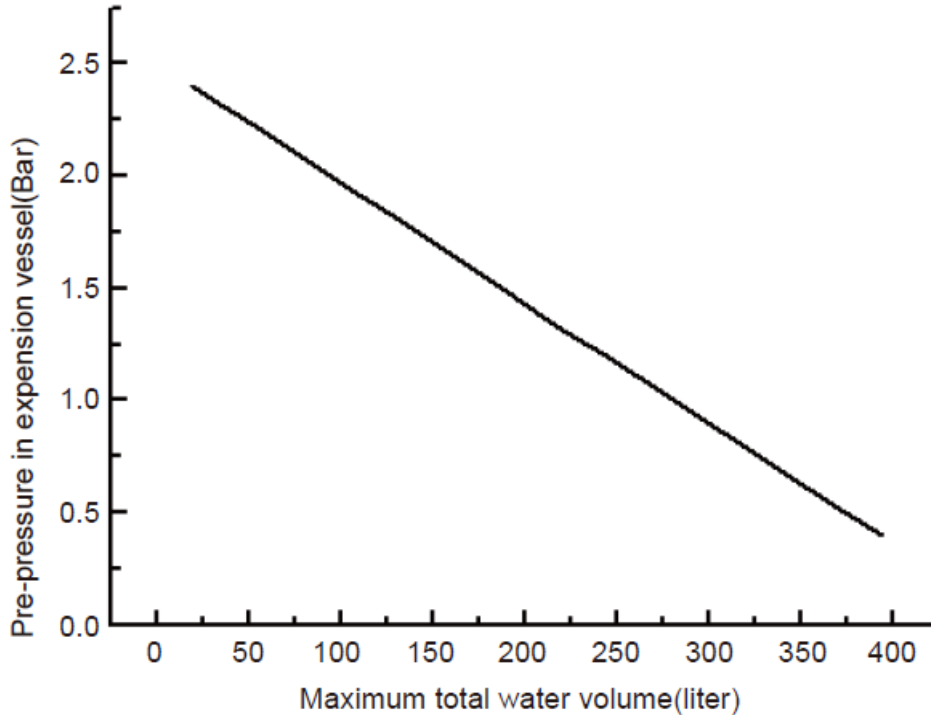

Note:

- (a) The expansion vessel is 10 liter and 1bar pre-pressurized;
- (b) Total water volume of 230 liter is default; if total water is changed because of installation condition, the prepressure should be adjusted to secure proper operation. If the indoor unit is located at the highest position, adjustment is not required;
- (c) Minimum total water volume is 20 liter;
- (d) To adjust pre-pressure, use nitrogen gas by certificated installer.

4.6.8 The method of calculating the charging pressure of expansion vessel

The method of calculating the charging pressure of expansion vessel needed to be adjusted is as follows. During installation, if the volume of water system has changed, please check if the pre-set pressure of the expansion vessel needs to be adjusted according to the following formula:

$$P_g = (H/10 + 0.3) \text{ Bar}$$

(H ---the difference between installing location of indoor unit and the highest spot of water system.)

Ensure that the volume of water system is lower than the maximum volume required in the above figure. If it exceeds the range, the expansion vessel does not meet the installing requirement.

Installation height ¹ difference	Water volume	
	≤230L	>230L
<7 m	Adjustment is not necessary	1. Pre-set pressure needs to be adjusted according to the above formula. 2. Check if the water volume is lower than the maximum water volume. (with help of the above figure)
>7 m	1. Pre-set pressure needs to be adjusted according to the above formula. 2. Check if the water volume is lower than the maximum water volume. (with help of the above figure)	The expansion vessel is too small and adjustment is not available. Please install additional expansion vessel at the external water circuit.

Note:

Installation height difference: the difference between installing location of indoor unit and the highest spot of water system; if the indoor unit is located at the highest point of the installation, the installation height difference is considered 0m.

Example 1: The 10kW unit is installed 5m below the highest spot of water system and the total volume of the water system is 230L.

Referring to the above figure, it is not necessary to adjust the pressure of the expansion vessel.

Example 2: The unit is installed on the highest spot of the water system and the total water volume is 300L.

As the volume of water system is higher than 230L, it is necessary to adjust the pressure of the expansion vessel be lower.

The formula of calculating pressure

$$P_g = (H/10 + 0.3) = (6/10 + 0.3) = 0.9 \text{ Bar}$$

The maximum volume of the water system is about 300L. As the actual volume of the water system is 300L, the expansion vessel meets the installing requirement.

Adjust the pre-set pressure of the expansion vessel from 1.0Bar to 0.9Bar.

4.6.9 Selection of expansion vessel

Formula:

$$V = \frac{C \cdot e}{1 - \frac{1 + P_1}{1 + P_2}}$$

V--- Volume of expansion vessel

C--- Total water volume

P1--- Pre-set pressure of expansion vessel

P2-- The highest pressure during running of the system (that is the action pressure of safety valve.)

e---The expansion factor of water (the difference between the expansion factor of the original water temperature and that of highest water temperature.)

Water expansion factor in different temperature	
Temperature	Expansion factor e
0	0.00013
4	0
10	0.00027
20	0.00177
30	0.00435
40	0.00782
45	0.0099
50	0.0121
55	0.0145
60	0.0171
65	0.0198
70	0.0227
75	0.0258
80	0.029
85	0.0324
90	0.0359
95	0.0396
100	0.0434

4.7 Connection of Pipeline

4.7.1 Connection of outlet pipe for indoor & outdoor unit

- (1) Align the expansion end of copper pipe with the center of threaded joint. Tighten the flaring nuts with your hands.
- (2) Tighten the flaring nuts with torque wrench until you hear a “click”.
- (3) Bend of fitting pipe shall not be too low; otherwise the fitting pipe might crack. Please use pipe bender when bending the fitting pipe.
- (4) When connecting outdoor and indoor unit, never pull the big and small joint of indoor unit with force, so as to prevent the tubes of indoor unit from cracking and causing leakage.
- (5) Connecting pipe shall be supported by a rack without transmitting its weight to other units.

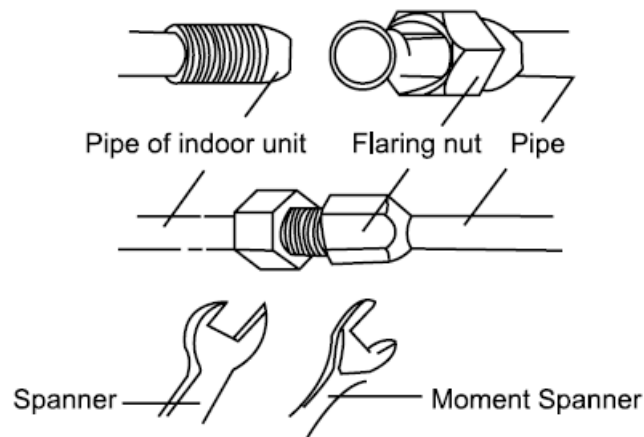

4.7.2 Installation of protective layer on connection pipe

- (1) To avoid condensate dew or water leakage on connecting pipe, the air pipe and liquid pipe must be wrapped with heat preservation material and adhesive pipe for insulation from the air.
- (2) The joints on indoor unit and outdoor unit must be wrapped with heat preservation materials and have no clearance against the wall surface of indoor unit and outdoor unit.
- (3) Wrap the pipe with tapes.
 - Use the adhesive tape to wrap the connecting pipe and cable into one bundle. To prevent condensate water from overflowing out of the drainpipe, the drainpipe shall be separated from connecting pipe and cable.
 - Wrap the heat preservation tape so that each ring of tape shall press half of the previous ring.
 - Fix the wrapped pipe onto the wall with pipe clamp.
 - Do not wrap the protective tape too tightly, as this will decrease the heat insulation performance.
 - After completing the protection work and wrapping the pipe properly, close the wall holes with sealing materials.

Unit Installation

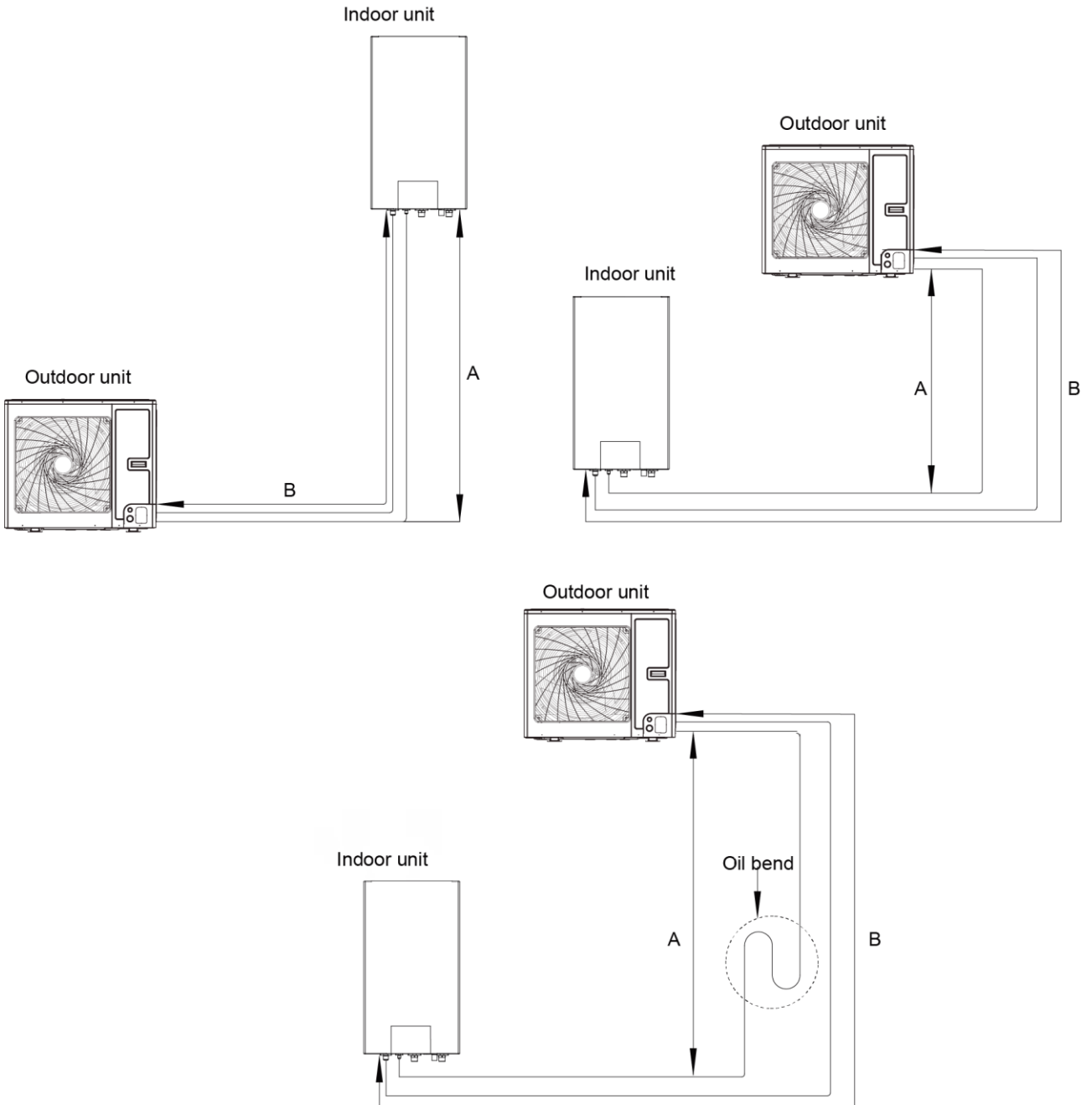
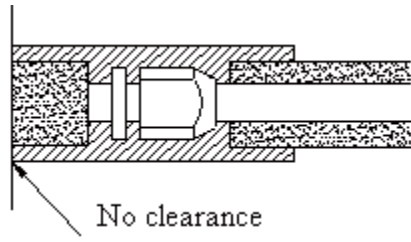

Model	Pipe size (Diameter:Φ)		Length B		Elevation A		Additional refrigerant
	gas	Liquid	Standard	Max.	Standard	Max.	
GSH-80ERB	1/2"	1/4"	5m	25m	0m	15m	16g/m
GSH-100ERB	1/2"	1/4"	5m	25m	0m	15m	16g/m

Notes

- (a) No additional charge of the refrigerant is need when the pipe length is less than 10m, if the pipe length is longer than 10m, additional charge of the refrigerant is needed according to the table.
- (b) Example: If 10kW model is installed at a distance of 30m, $(30-10) \times 16 = 320g$ refrigerant should be added. Rated capacity is based on standard pipe length and maximum allowable length is based on the product reliability in the operation. Oil trap should be installed every 5-7 meters when the location of outdoor unit is higher than indoor unit.

4.8 Installation of Water Tank

4.8.1 Installation measure

The insulated water tank should be installed and keep levelly within 5m and vertically within 3m from the indoor unit. It can be installed in the room.

Standing water tank must be installed vertically with the bottom on the ground, never suspended. Installation place must be firm enough and the water tank should be fixed on the wall with bolts to avoid vibration, as shown in the following figure. Weight capacity of water tank during installation should also be considered.

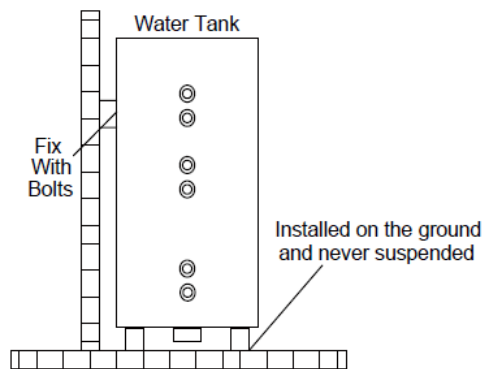

The minimum clearance from the water tank to combustible surface must be 500mm.

There should be water pipe, hot water joint and floor drain near the water tank in favor of water replenishment, hot water supply and drainage of water tank.

Connection of inlet/outlet waterway: Connect the safety check valve attached with the unit (with the arrow on it pointing at the water tank) with the water inlet of water tank with PPR pipe according to the following figure, sealing with unsintered tape. The other end of the safety check valve should connect with tap water joint. Connect the hot water pipe and water outlet of water tank with PPR pipe.

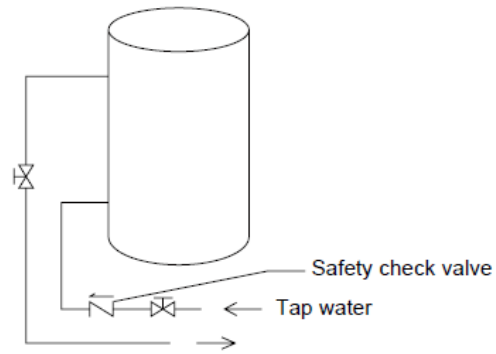

Note

For safe use of water, water outlet/inlet of water tank must connect with a certain length of PPR pipe , $L \geq 70 \times R2$ (cm, R is inside radius of the pipe). Moreover, heat preservation should be conducted and metal pipe cannot be used. For the first use, water tank must be full of water before the power is on.

4.8.3 Connection of waterway system

(1) If connection between water tank and indoor unit should be through the wall, drill a hole $\phi 70$ for pass of circulating water pipe. It is unnecessary if the hole is not needed.

(2) Preparation of pipelines: Circulating water outlet/inlet pipe must be hot water pipe, PPR pipe with nominal out diameter of dn25 and S2.5 series (wall thickness of 4.2mm) being recommended. Cooling water inlet pipe and hot water outlet pipe of water tank should also be hot water pipe, PPR pipe with nominal out diameter of dn20 and S2.5 series (wall thickness of 3.4mm) being recommended. If other insulated pipes are adopted, refer to the above dimensions for out diameter and wall thickness.

(3) Installation of circulating water inlet/outlet pipes: connect the water inlet of the unit with circulating outlet of water tank and water outlet of unit with circulating inlet of water tank.

(4) Installation of water inlet/outlet pipes of the water tank: safety check valve, filter and cut-off valve must be installed for the water inlet pipe according to the installation sketch of the unit. At least a cut-off valve is needed for the water outlet pipe.

(5) Installation of blow-off pipes at the bottom of water tank: connect a piece of PPR pipe with

drainage outlet to floor drain. A cut-off valve must be installed in the middle of the drainage pipe and at the place where it is easy to be operated by the users.

(6) After connection of all waterway pipelines, perform the leakage test firstly. After that, bind up the water pipes, water temp sensor and wires with wrapping tapes attached with the unit.

(7) Refer to Installation Sketch of the Unit for details.

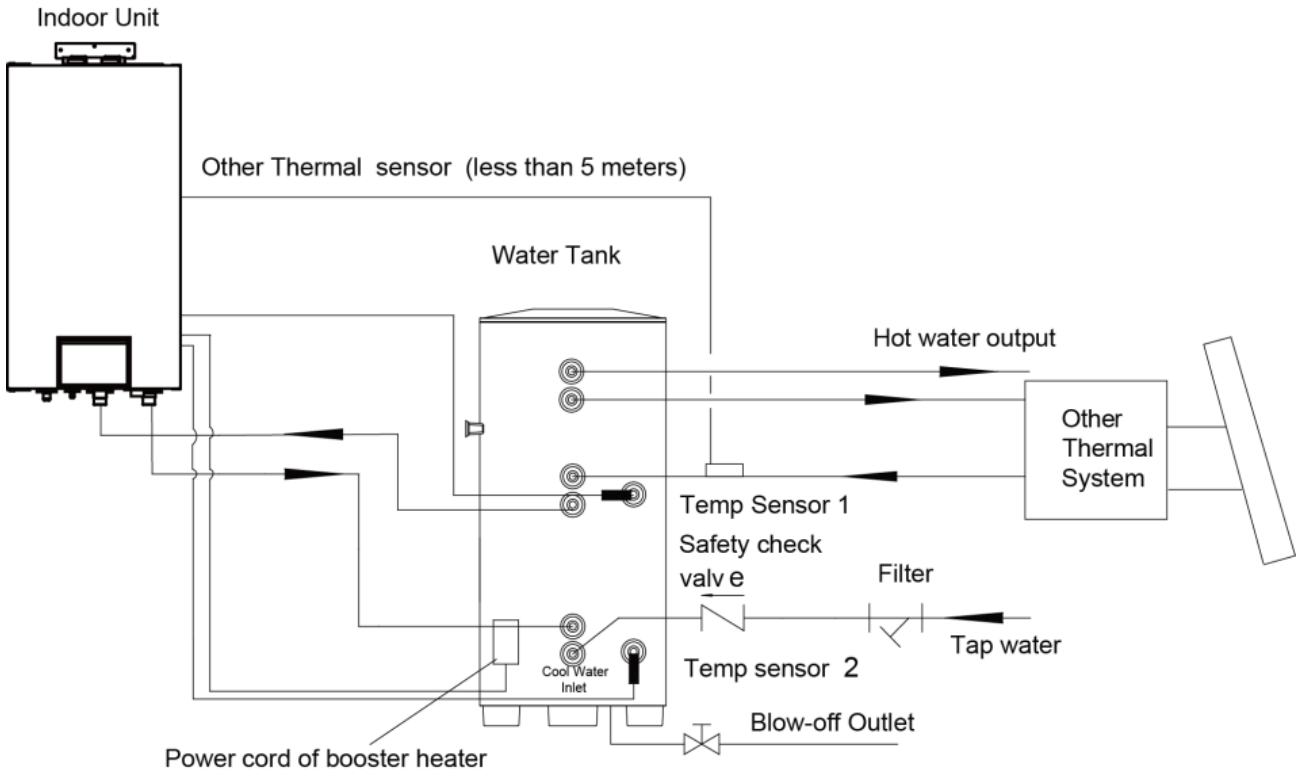

Description	Joint pipe thread
Circulating water inlet/outlet of main unit	1"Male BSP
Cooling water inlet of water tank	1/2"Female BSP
Circulating water inlet/outlet of water tank	3/4"Female BSP
Hot water outlet of water tank	1/2"Female BSP

Notes

- (a) Distance between indoor unit and water tank should not exceed 5m levelly and 3m vertically. If higher, please contact with us. Water tank on lower and main unit on higher side is recommended.
- (b) Prepare the materials according to the above joints dimension. If cut-off valve is installed outside the room, PPR pipe is recommended to avoid freeze damage.
- (c) Waterway pipelines can't be installed until water heater unit is fixed. Do not let dust and other sundries enter into pipeline system during installation of connection pipes.
- (d) After connection of all waterway pipelines, perform leakage test firstly. After that, perform heat preservation of waterway system; meanwhile, pay more attention to valves and pipe joints. Ensure enough thickness of insulated cotton. If necessary, install heating device for pipeline to prevent the pipeline from freezing.
- (e) Hot water supplied from insulated water tank depends on pressure of water tap, so there must be supply of tap water.
- (f) During using, the cut-off valve of cooling water inlet of water tank should be kept normally on.

4.9 Requirements on water quality

Paramete	Parametric value	Unit
pH(25°C)	6.8–8.0	
Cloudy	< 1	NTU
Chloride	< 50	mg/L
Fluoride	< 1	mg/L
Iron	< 0.3	mg/L
Sulphate	< 50	mg/L
SiO ₂	< 30	mg/L
Hardness(count CaCO ₃)	< 70	mg/L
Nitrate(count N)	< 10	mg/L
Conductance(25°C)	< 300	µs/cm
Ammonia (count N)	< 0.5	mg/L
Alkalinity(count CaCO ₃)	< 50	mg/L
Sulfid	Cannot be detected	mg/L
Oxygen consumption	< 3	mg/L
Natrium	< 150	mg/L

4.10 Electric Wiring

(1) Wiring diagram

Wiring diagrams stuck to the unit always prevails.

- ◆ GSH-80IRB, GSH-100IRB

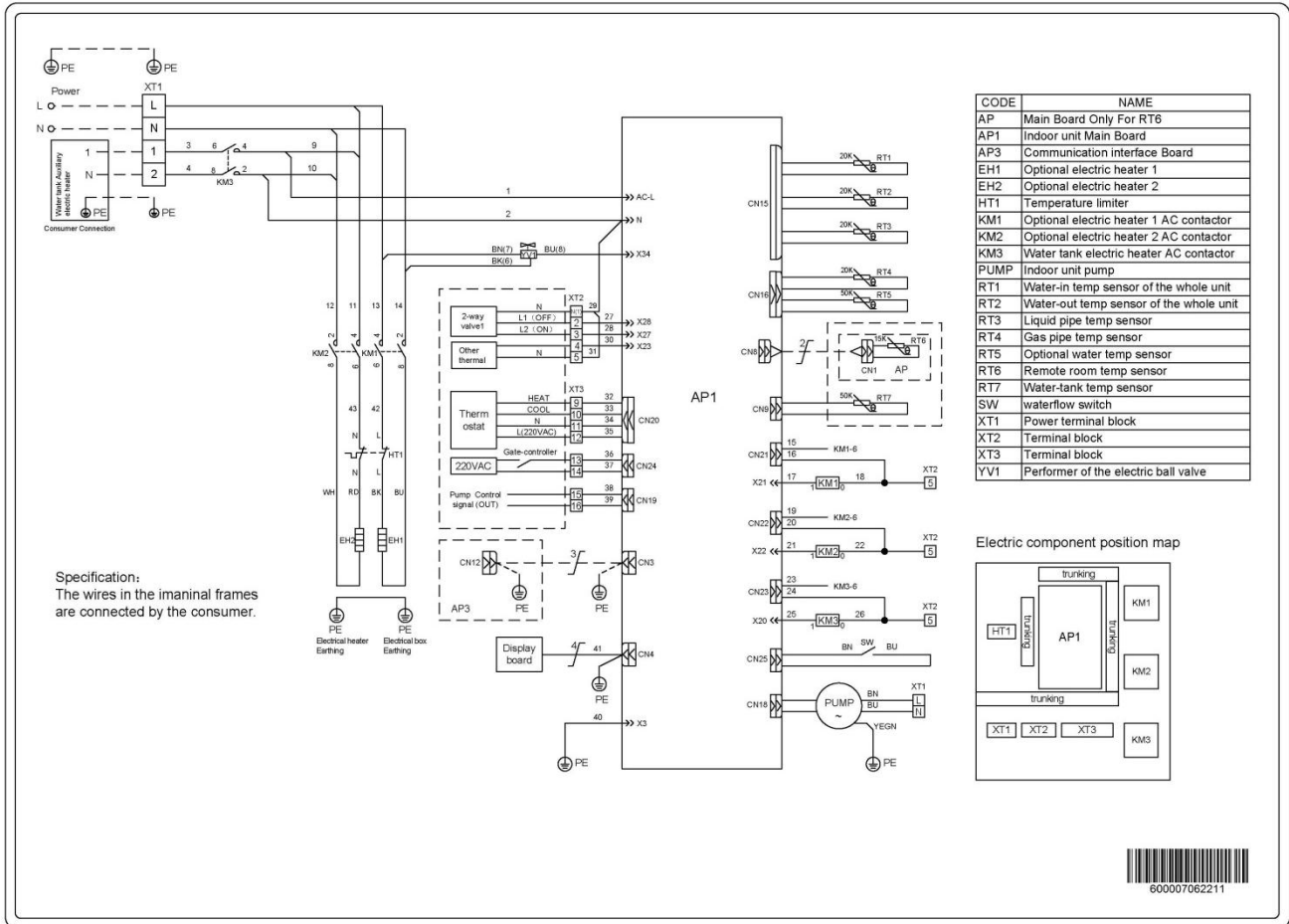

◆ GSH-80ERB, GSH-100ERB

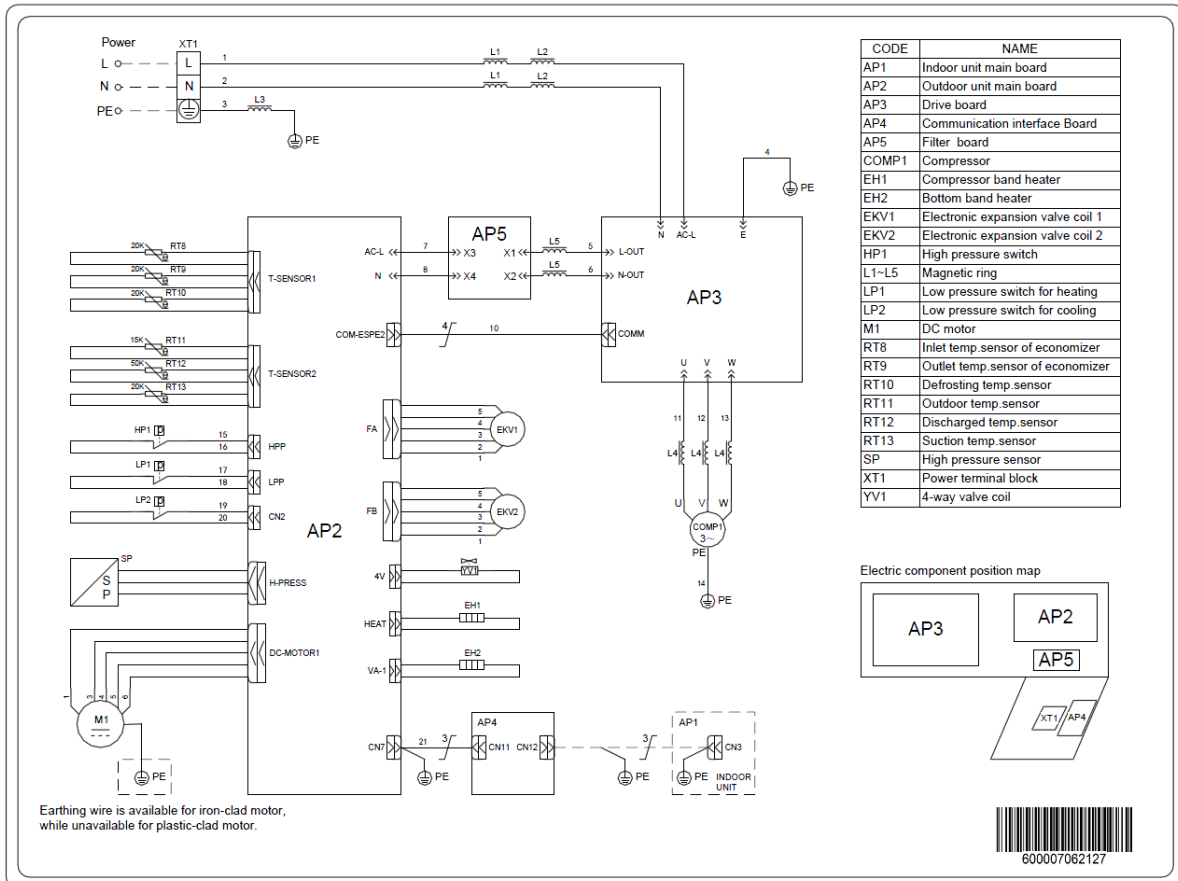

4.11 Wiring of the Terminal Board

- ◆ GSH-80IRB, GSH-100IRB

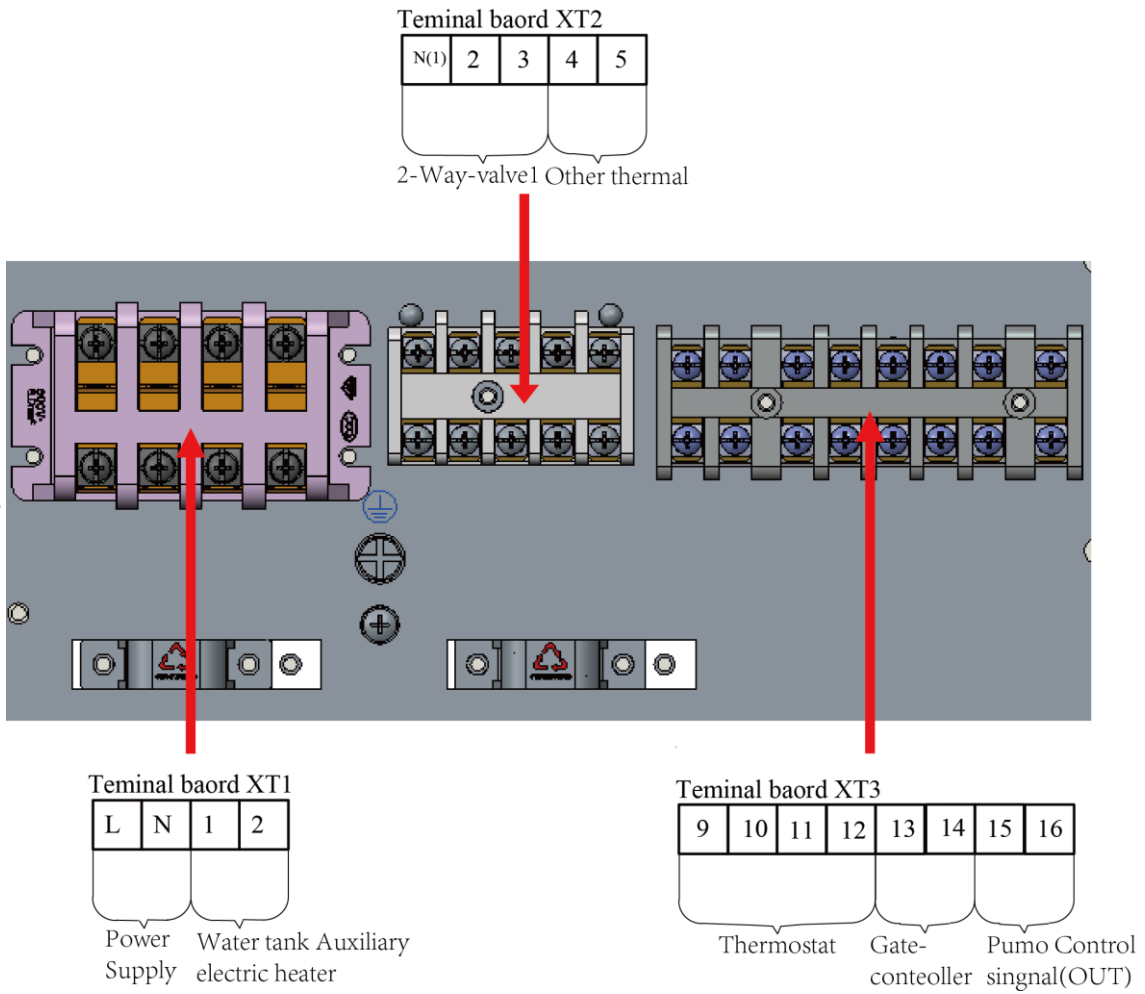

4.12 Wiring of the 2-Way Valve

The 2-way valve 1 is required to control water flow for cooling or heating operation. The role of 2-way valve 1 is to cut off water flow into the underfloor loop when the fan coil unit is equipped for cooling operation.

General Information

Type	Power	Operating Mode	Supported
NO 2-wire	230VAC 50Hz	Closing water flow	Yes
		Opening water flow	Yes
NC 2-wire	230VAC 50Hz	Closing water flow	Yes
		Opening water flow	Yes

- (1) Normal Open type. When electric power is NOT supplied, the valve is open. (When electric power is supplied, the valve is closed.)
- (2) Normal Closed type. When electric power is NOT supplied, the valve is closed. (When electric power is supplied, the valve is open.)

How to Wire 2-Way Valve:

Follow steps below to wire the 2-way valve.

Step 1. Uncover the front cover of the unit and open the control box.

Step 2. Find the terminal block and connect wires as below.

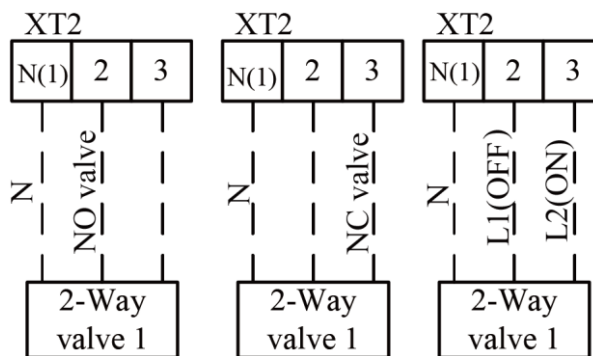

⚠ WARNING!

- (1) Normal Open type should be connected to wire (OFF) and wire (N) for valve closing in cooling mode.
- (2) Normal Closed type should be connected to wire (ON) and wire (N) for valve closing in cooling mode.

(ON): Live signal (for Normal Open type) from PCB to 2-way valve

(OFF): Live signal (for Normal Closed type) from PCB to 2-way valve

(N): Neutral signal from PCB to 2-way valve

4.13 Wiring of Other Thermal

Other thermal is allowed for the equipment and controlled in such a way that the mainboard will output 230V when outdoor temperature is lower than the set point for startup of the aother thermaluxiliary heat source.

Note: Other thermal and Optional Electric Heater CANNOT be installed at the same time.

Step 1. Other thermal installation

Other thermal should be installed with monobloc unit parallel. Moreover, an accessory called optional

Unit Installation

water temperature sensor(5 meter length) shall be installed at the same time.

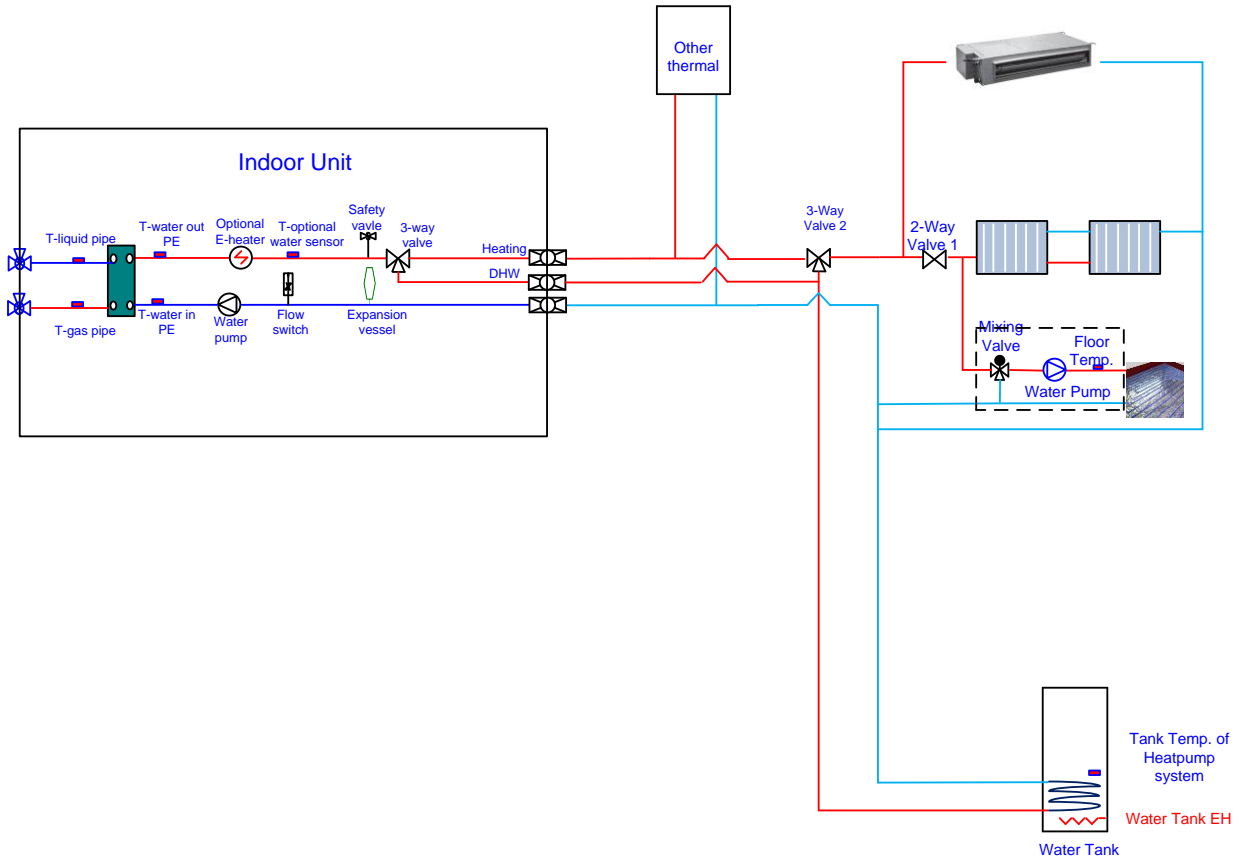

Step 2. Electric wiring work

Other thermal L and N are connected to XT3~21, 22.

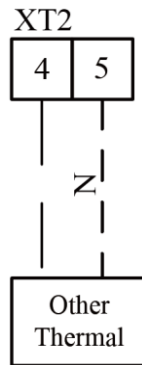

Optional water temperature sensor is connected to AP1 CN16.

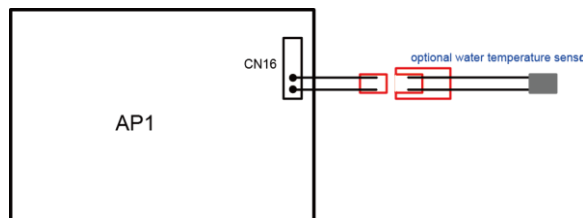

Step 3. Wired controller setting

Other thermal should be selected "with" if necessarily from COMMISSION → FUNCTION, then set switch on (outdoor)temperature and control logic(1/2/3).

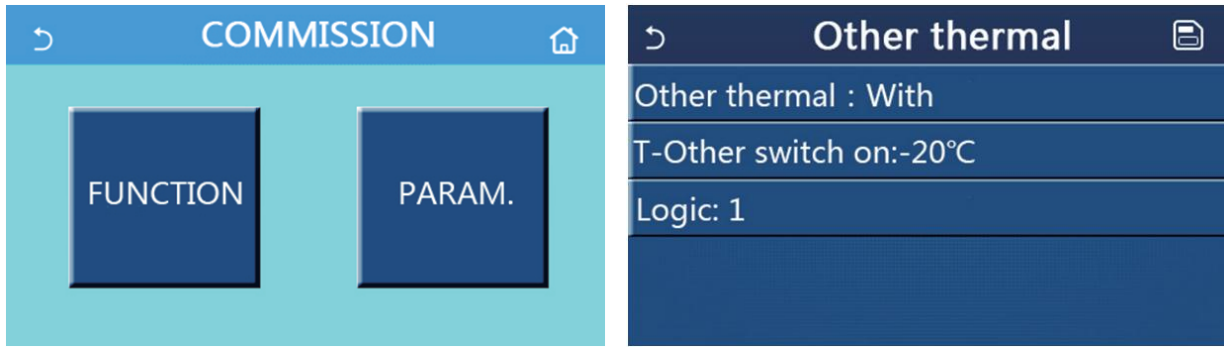

4.14 Wiring of the Gate-Controller

If there is gate control function, installation guide follow as:

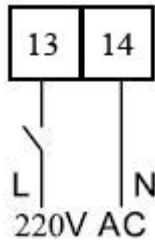

4.15 Wiring of the Remote Air Temperature Sensor



Front side



Back side

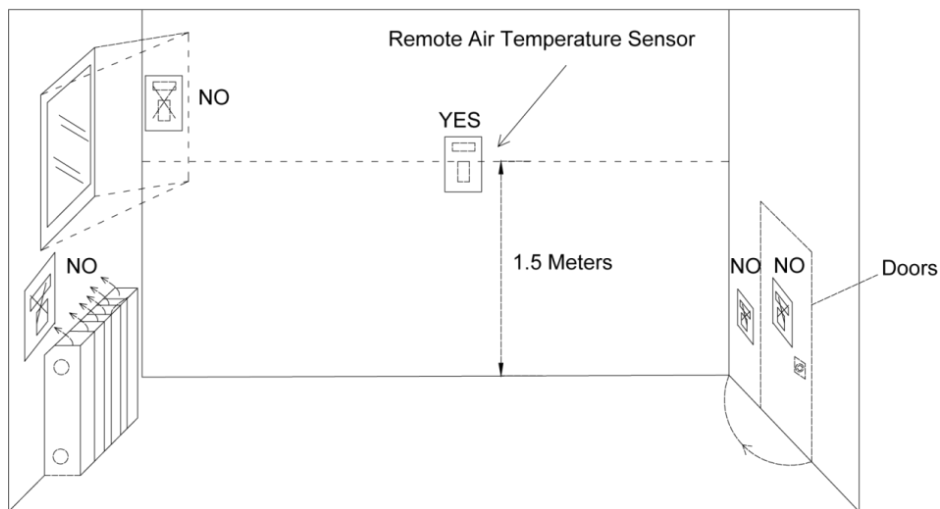

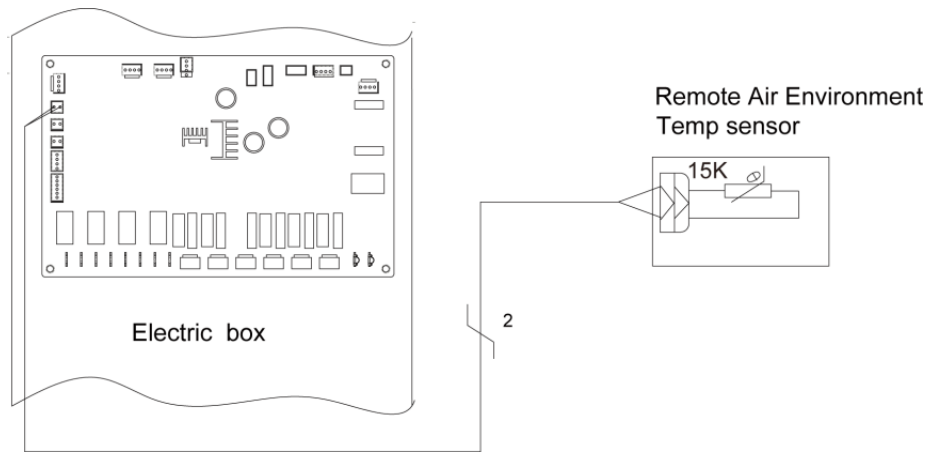

Notes:

- ① Distance between the indoor unit and the remote air temperature sensor should be less than 15m due to length of the connection cable of remote air temperature sensor;
- ② Height from floor is approximately 1.5m;
- ③ Remote air temperature sensor cannot be located where the area may be hidden when door is open;
- ④ Remote air temperature sensor cannot be located where external thermal influence may be applied;
- ⑤ Remote air temperature sensor should be installed where space heating is mainly applied;
- ⑥ After the remote air temperature sensor is installed, it should be set to "With" through the wired controller so as to set the remote air temperature to the control point.

4.16 Wiring of the Thermostat

Installation of the thermostat is very similar to that of the remote air temperature sensor.

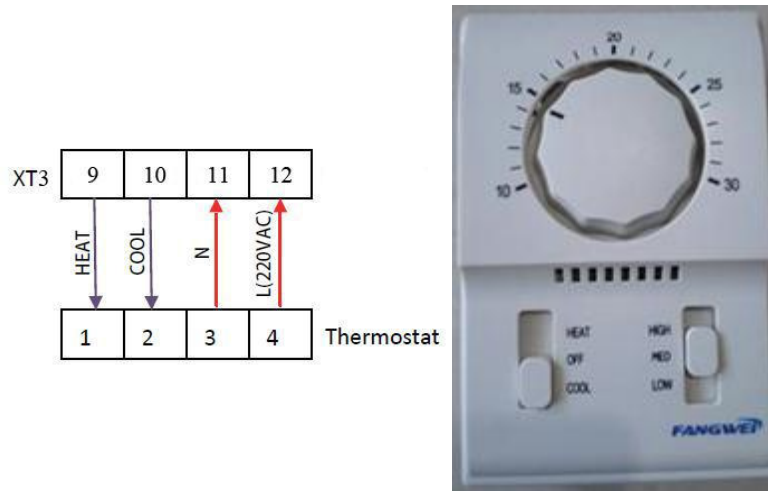

How to Wire Thermostat

- (1) Uncover the front cover of indoor unit and open the control box ;
- (2) Identify the power specification of the thermostat, it is 230V, find terminal block XT4 as NO.23~26;
- (3) If it is the heating/cooling thermostat, please connect wire as per the figure above.

⚠ CAUTION!

- ① 220V power supply can be provided to the thermostat by the Versati III heat pump.
- ② Setting temperature by the thermostat (heating or cooling) should be within the temperature range of the product ;
- ③ For other constrains, please refer to previous pages about the remote air temperature sensor;
- ④ Do not connect external electric loads. Wire 220V AC should be used only for the electric thermostat;
- ⑤ Never connect external electric loads such as valves, fan coil units, etc. If connected, the mainboard of the unit can be seriously damaged;
- ⑥ Installation of the thermostat is very similar to that of the remote air temperature sensor.

4.17 Wiring of the Control

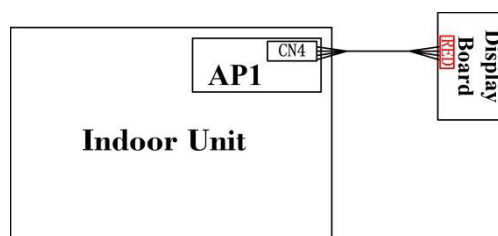

Notes:

- ① The wired controller can be connected to the terminal of AP1 CN4 with the four-wire communication cable.

5 Commissioning and Trial Run

5.1 Check before startup





For safety of users and unit, the unit must be started up for check before debugging. The procedures are as below:

The following items shall be performed by qualified repair persons.		
Confirm together with the sales engineer, dealer, installing contractor and customers for the following items finished or to be finished.		
No.	Confirmation of Installation	√
1	If the contents of Application for Installation of this Unit by Installer are real. If not, debugging will be refused.	<input type="checkbox"/>
2	Is there written notice in which amendment items are shown in respect of unqualified installation?	<input type="checkbox"/>
3	Are Application for Installation and Debugging list filed together?	<input type="checkbox"/>
No.	Pre-check	√
1	Is appearance of the unit and internal pipeline system ok during conveying, carrying or installation?	<input type="checkbox"/>
2	Check the accessories attached with the unit for quantity, package and so on.	<input type="checkbox"/>
3	Make sure there is drawings in terms of electricity, control, design of pipeline and so on.	<input type="checkbox"/>
4	Check if installation of the unit is stable enough and there is enough space for operation and repair.	<input type="checkbox"/>
5	Completely test refrigerant pressure of each unit and perform leakage detection of the unit.	<input type="checkbox"/>
6	Is the water tank installed stably and are supports secure when the water tank is full?	<input type="checkbox"/>
7	Are heat insulating measures for the water tank, outlet/inlet pipes and water replenishing pipe proper?	<input type="checkbox"/>
8	Are the nilometer of water tank, water temperature indicator, controller, manometer, pressure relief valve and automatic discharge valve etc. installed and operated properly?	<input type="checkbox"/>
9	Does power supply accord with the nameplate? Do power cords conform to applicable requirements?	<input type="checkbox"/>
10	Is power supply and control wiring connected properly according to wiring diagram? Is earthing safe? Is each terminal stable?	<input type="checkbox"/>
11	Are connection pipe, water pump, manometer, thermometer, valve etc. are installed properly?	<input type="checkbox"/>
12	Is each valve in the system open or closed according to requirements?	<input type="checkbox"/>
13	Confirm that the customers and inspection personnel of Part A are at site.	<input type="checkbox"/>
14	Is Installation Check-up Table completed and signed by the installation contractor?	<input type="checkbox"/>
Attention: If there is any item marked with x, please notify the contractor. Items listed above are just for reference.		
Confirmed items after pre-checking	General Evaluation: Debugging <input type="checkbox"/> Amendment <input type="checkbox"/>	
	Judge the following items (if there is not any filling, qualification will be regarded.)	
	a: Power supply and electric control system	b: Loading calculation
	c: Heating problems of Unit	d: Noise problem
	e: Pipeline problem	f: Others

	Normal debugging work can't be performed unless all installation items are qualified. If there is any problem, it must be solved firstly. The installer will be responsible for all costs for delay of debugging and re-debugging incurred by any problem which is not solved immediately.
	Submit schedule of amending reports to installer.
	Is the written amending report which should be signed after communication provided to installer?
	Yes () No ()

5.2 Test run

Test run is testing whether the unit can run normally via preoperation. If the unit cannot run normally, find and solve problems until the test run is satisfactory. All inspections must meet the requirements before performing the test run. Test run should follow the content and steps of the table below:

The following procedure should be executed by experience and qualified maintenance men.	
No.	Start up the pretest procedure
Notice: before test, ensure that all power must be cut off, including the far- end power switch, otherwise, it may cause casualty.	
1	Ensure that the compressor of the unit is preheated for 8h.
 Caution: heat the lubricating oil at least 8h in advance to prevent refrigerant from mixing with the lubricating oil, which may cause damage to the compressor when starting up the unit.	
2	Check whether the oil temperature of the compressor is obviously higher than the outdoor ambient temperature.
 Caution: if the oil temperature of the compressor is obviously higher than the outdoor ambient temperature, it means that the heating tape of compressor is damaged. In that case, the compressor will be damaged easily. Therefore, repair the heating tape before using the unit.	
3	Check whether the phase sequence of the main power supply is correct. If not, correct the phase sequence firstly.
 Recheck the phase sequence before start-up to avoid reverse rotation of the compressor which may damage the unit.	
4	Apply the universal electric meter to measure the insulation resistance between each outdoor phase and earth as well as between phases.
 Caution: defective earthing may cause electric shock.	
No.	Ready to start
1	Cut off all temporary power supply, resume all the insurance and check the electricity for the last time.
	Check the power supply and voltage of the control circuit; _____V must be $\pm 10\%$ within the range of rated operating power.
No.	Start up the unit
1	Check all the conditions needed to start up the unit: oil temperature, mode, required load etc.
2	Start up the unit, and observe the operation of compressor, electric expanding valve, fan motor and water pump etc.
	Note: the unit will be damaged under abnormal running state. Do not operate the unit in states of high pressure and high current.

Unit Installation

Others:	
Items for acceptance after debugging	Estimation or suggestion on the general running situation: good, modify
	Identify the potential problem (nothing means the installation and debugging are in accordance with the requirements.)
	a. problem of power supply and electric control system:
	b. problem of load calculation:
	c. outdoor refrigerant system:
	d. noise problem:
	e. problem of indoor and piping system:
	h. other problems:
During operation, it is needed to charge for the maintenance due to non-quality problems such as incorrect installation and maintenance.	
Acceptance	
Is the user trained as required? Please sign. Yes() No()	

TEST OPERATION & TROUBLESHOOTING & MAINTENANCE

1 Trial Run

1.1 Check for Wiring

⚠ WARNING!

Do not check for the power supply unless proper checkout equipment has prepared and preventive measures have been taken, otherwise it would lead to severe injury.

- ◆ Are sizes of connection lines and the air switch proper?
- ◆ Does wiring comply with relative standards and electric codes?
- ◆ Is there any incorrect wiring?
- ◆ Does each contact work properly?
- ◆ Is the power supply and insulation proper?
- ◆ Are initial set points of control and protective elements satisfied?

1.2 Check for the Water System

- ◆ Are water inlet and outlet directions correct?
- ◆ Is the water piping cleaned? Are there foreign matters at the pipe joints? Is the water quality satisfied?
- ◆ Is insulation of water pipes in good condition?
- ◆ Does exhaust valve of the water system work properly?

1.3 Check for the Communication System

When the unit is powered on, check for the communication system, including: communication between AP1 and AP2, between the wired controller and the main board. When there is unusual communication, this error will be displayed at the wired controller. Then, check out the cause according to the displayed error. See the figure below for wiring of the communication system.

1.4 Trial Run

Start the unit when there is no any problem for wiring and piping. After startup, check for the electrostatic expansion valve, water pump, fan, and compressor to see if they work normally. When there is any error, solve it according to the troubleshooting flowchart covered in this manual. However, if the troubleshooting flowchart is still unhelpful, please contact GREE sales agent.

2 Error Code List

No.	Full Name	Displayed Name	Error Code
1	Ambient temperature sensor error	Ambient sensor	F4
2	Defrosting temperature sensor error	Defrost sensor	d6
3	Discharge temperature sensor error	Discharge sensor	F7
4	Suction temperature sensor error	Suction sensor	F5
5	Economizer inlet temperature sensor	Econ. in sens.	F2
6	Economizer outlet temperature sensor	Econ. out sens.	F6
7	Fan error	Outdoor fan	EF

Test Operation & Troubleshooting & Maintenance

No.	Full Name	Displayed Name	Error Code
8	High pressure protection	High pressure	E1
9	Low pressure protection	Low pressure	E3
10	High discharge protection	Hi-discharge	E4
11	Capacity DIP switch error	Capacity DIP	c5
12	Communication error between the outdoor and indoor main boards	ODU-IDU Com.	E6
13	Communication error between the outdoor main board and the drive board	Drive-main com.	P6
14	Communication error between the display panel and indoor main board	IDU Com.	E6
15	High pressure sensor error	HI-pre. sens.	Fc
16	Leaving water temperature sensor error for the plate type heat exchanger of the heat pump	Temp-HELW	F9
17	Leaving water temperature sensor error for the auxiliary electric heat of the heat pump	Temp-AHLW	dH
18	Entering water temperature sensor error of the plate type heat exchanger of the heat pump	Temp-HEEW	No error code but displayed on control pannel
19	Water tank temperature sensor error ("NA" for mini chillers)	Tank sens.	FE
20	Remote room temperature sensor error	T-Remote Air	F3
21	Protection for the flow switch of the heat pump	HP-Water Switch	Ec
22	Welding protection to the auxiliary electric heater 1 of the heat pump	Auxi. heater 1	EH
23	Welding protection to the auxiliary electric heater 2 of the heat pump	Auxi. heater 2	EH
24	Welding protection to the water tank electric heater	Auxi. -WTH	EH
25	DC bus under-voltage or voltage drop error	DC under-vol.	PL
26	DC bus over-voltage	DC over-vol.	PH
27	AC current protection (input side)	AC curr. pro.	PA
28	IPM defective	IPM defective	H5
29	PFC defective	PFC defective	Hc
30	Start failure	Start failure	Lc
31	Phase loss	Phase loss	Ld
32	Jumper cap error	Jumper cap error	c5
33	Driver resetting	Driver reset	P0
34	Compressor overcurrent	Com. over-cur.	P5
35	Overspeed	Overspeed	LF
36	Current sensing circuit error or current sensor error	Current sen.	Pc
37	Desynchronization	Desynchronize	H7
38	Compressor stalling	Comp. stalling	LE

Test Operation & Troubleshooting & Maintenance

No.	Full Name	Displayed Name	Error Code
39	Radiator or IPM or PFC over-temperature	Overtemp.-mod.	P8
40	Radiator or IPM or PFC temperature sensor error	T-mod. sensor	P7
41	Charging circuit error	Charge circuit	Pu
42	AC input voltage error	AC voltage	PP
43	Ambient temperature sensor error at the drive board	Temp-driver	PF
44	AC contactor protection or input over-zero error	AC contactor	P9
45	Temperature drift protection	Temp. drift	PE
46	Sensor connection protection (the current sensor fails to be connected with the corresponding phase U and or phase V)	Sensor con.	Pd
47	Communication error between the display panel and the outdoor unit	ODU Com.	E6
48	Refrigerant vapor line temperature sensor error	Temp RGL	F0
49	Refrigerant liquid line temperature sensor error	Temp RLL	F1
50	4-way valve error	4-way valve	U7

3 Flow Chart of Troubleshooting

3.1 Comp High-pressure Protection E1

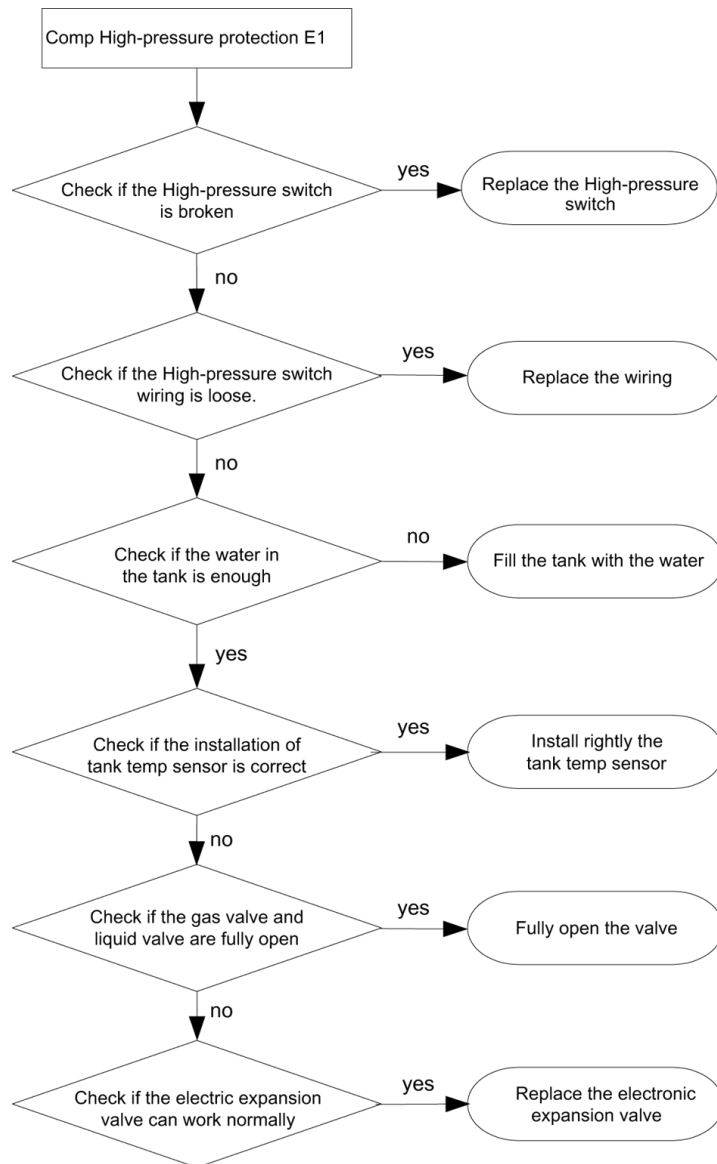

3.2 Comp Low- pressure Protection E3

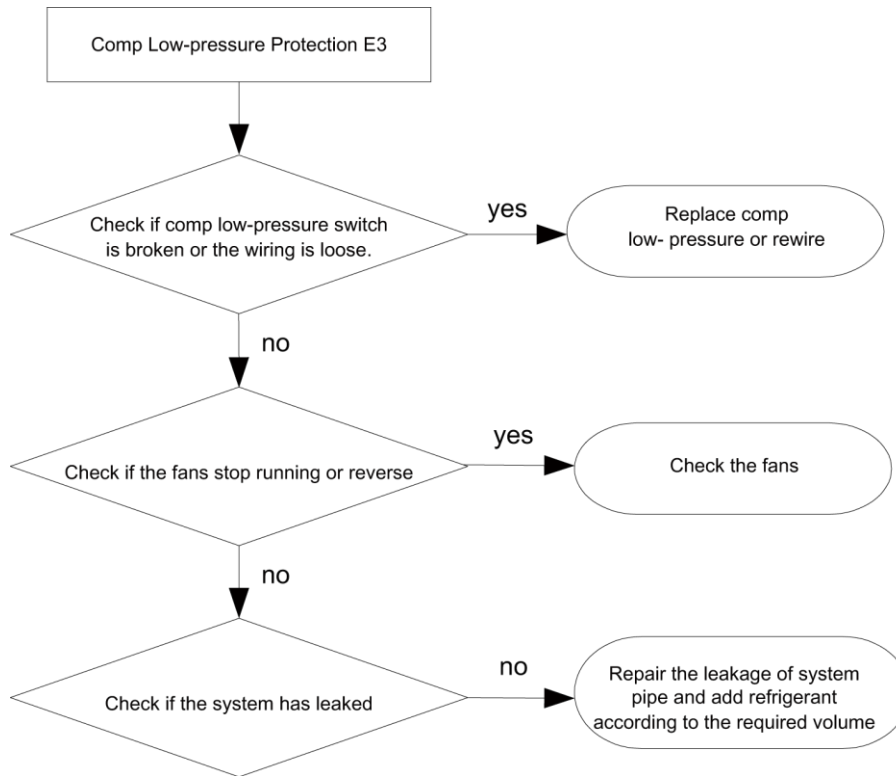

3.3 Comp Discharge Temp Protection E4

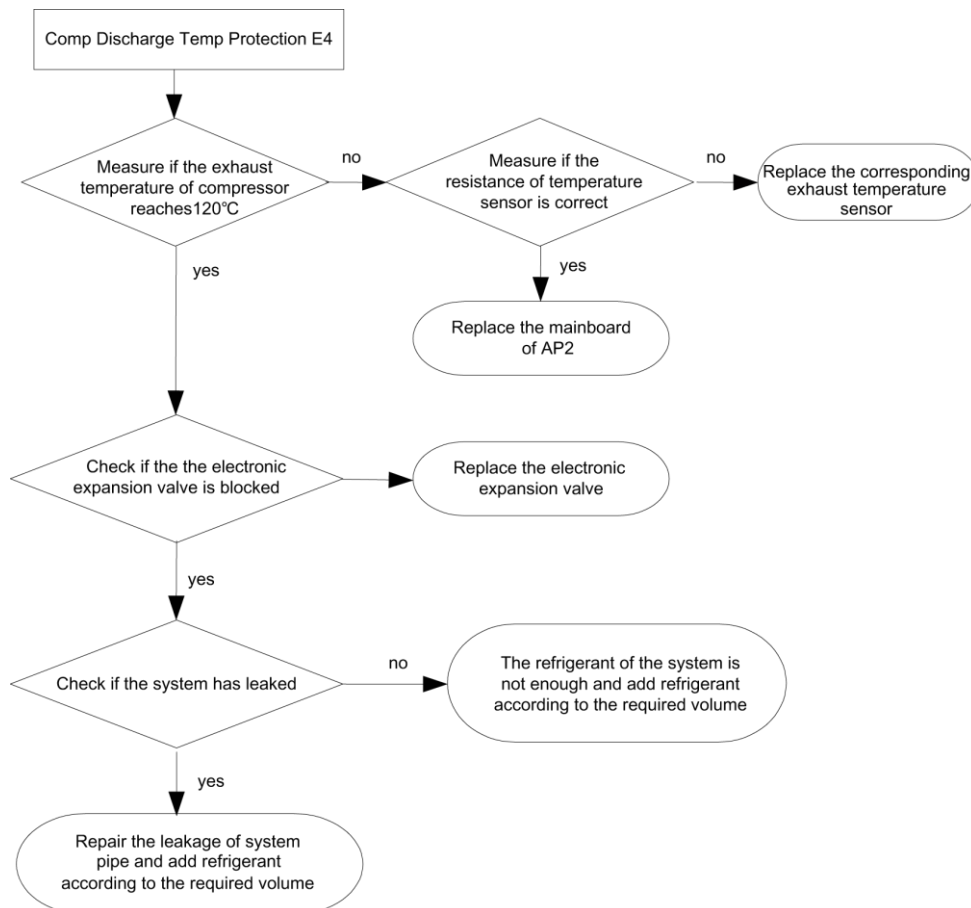

3.4 Overload Protection of Compressor or Driver Error

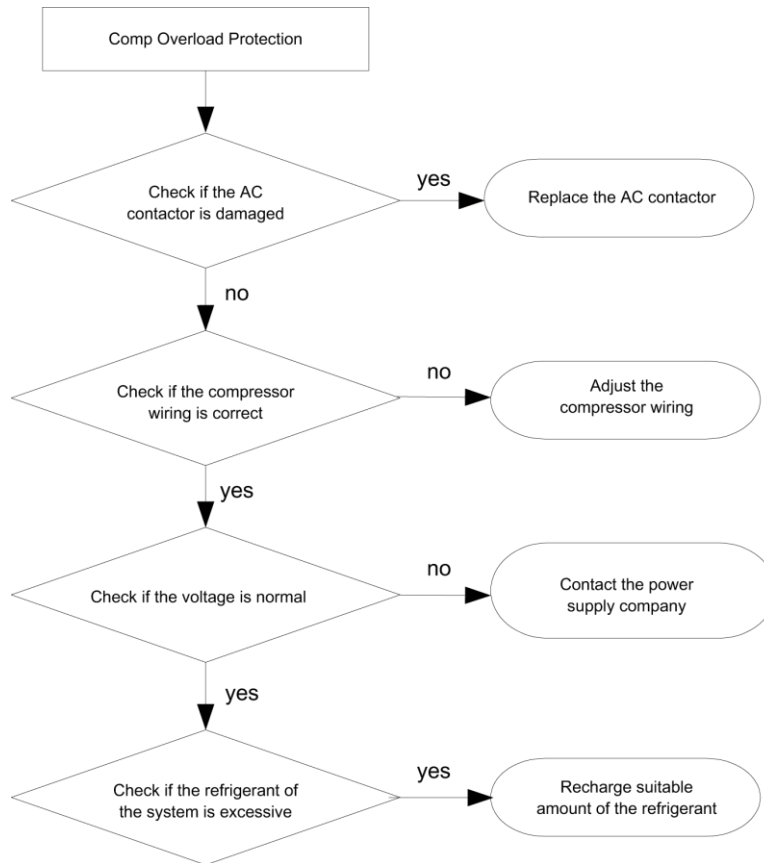

3.5 DC Fan Error EF

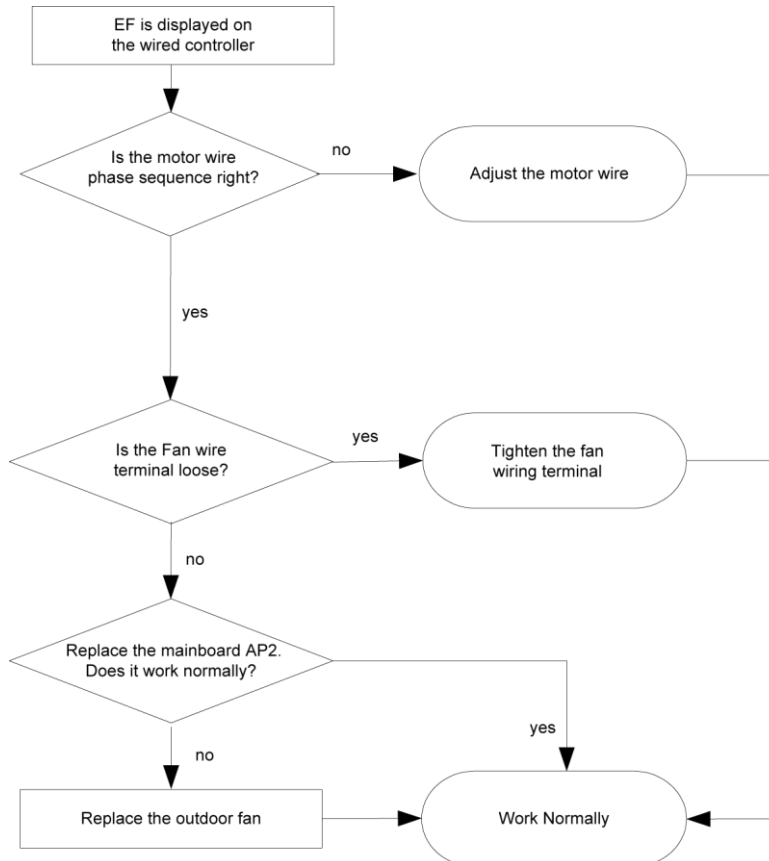

3.6 Temperature Sensor Error

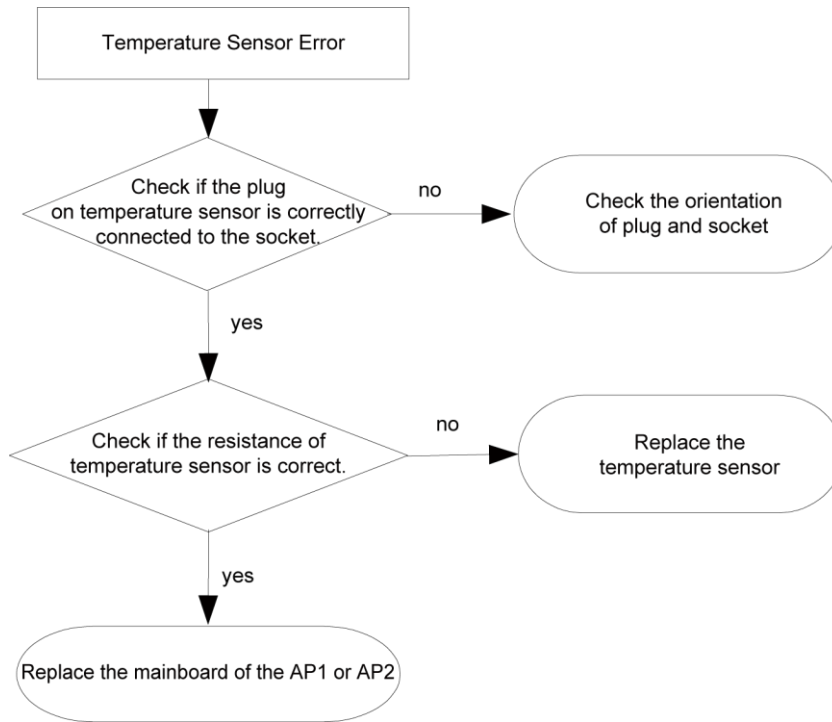

3.7 Communication Malfunction E6

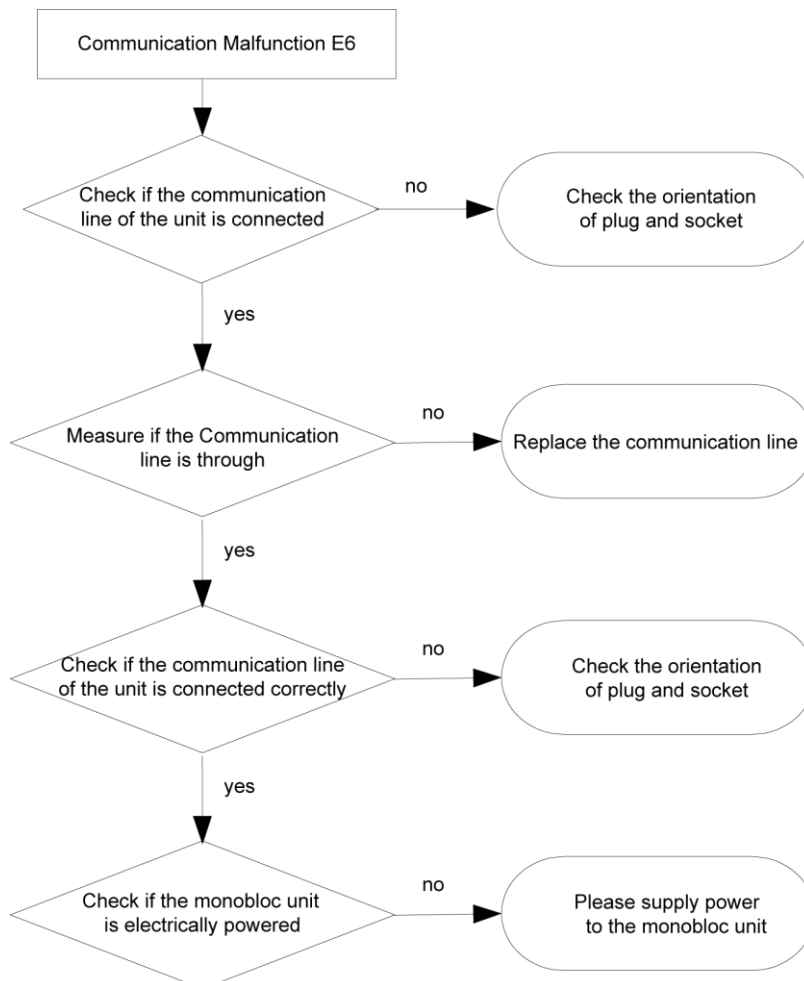

3.8 Capacity Switch Error (Code:"C5")

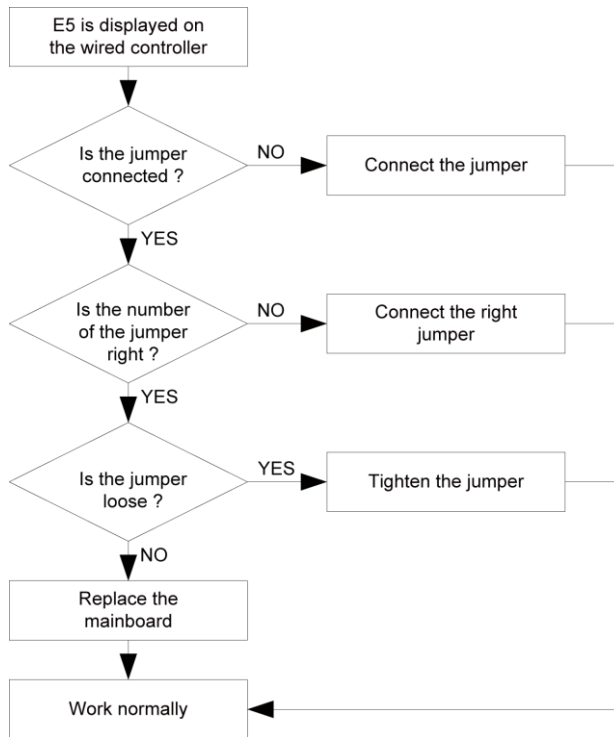

4 Diagnosis of Driving

4.1 Diagnosis Flowchart of Driving of Single-phase Unit and Three-phase Unit

Unit

- ◆ Drive Module Reset(Code:"P0") ; IPM or PFC Temperature Sensor Error(Code:"P7") ; AC Current Protection (Input Side)(Code:"PA"); Current Sense Circuit Error(code:"PC"); PFC Protection(Code:"HC")

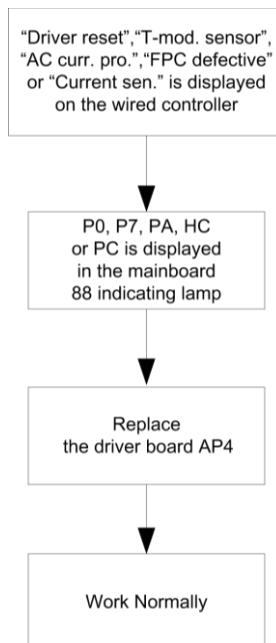

◆ IPM or PFC Over-temperature Protection(Code:"P8")

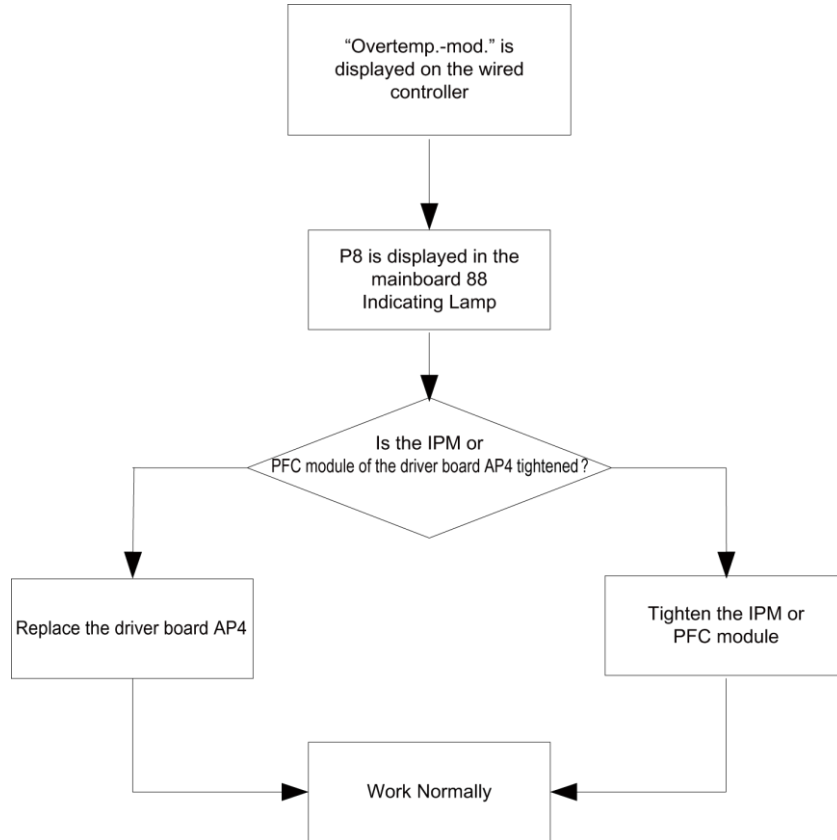

◆ DC Busbar Over-voltage Protection(Code:"PH") ; DC Busbar Under-voltage Protection (Code:"PL")

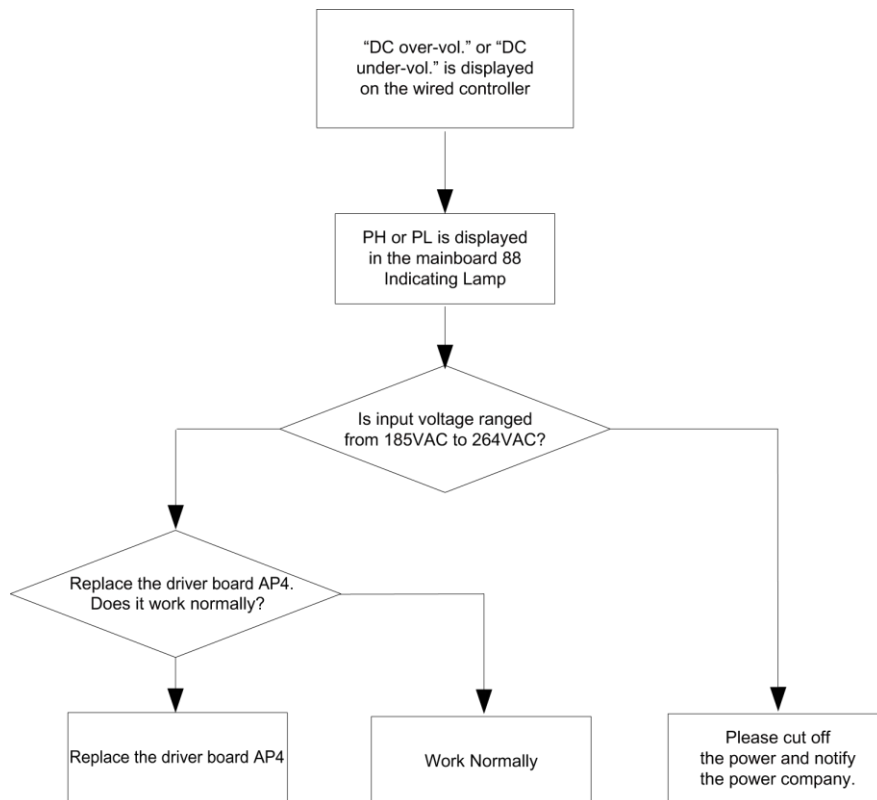

Note: three-phase input voltage is in the range from 320VAC to 475VAC.

◆ Drive-to-main-control Communication Error(Code:"P6")

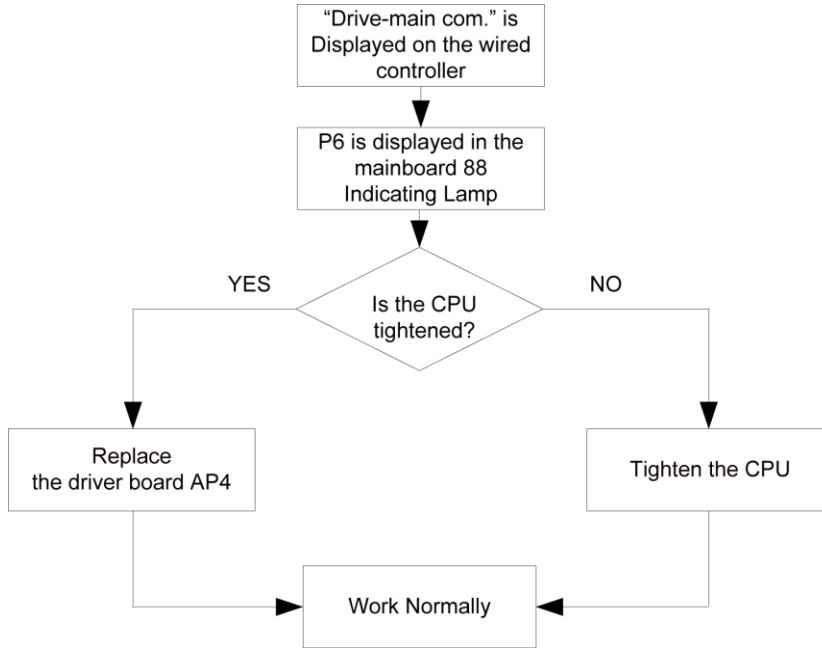

◆ Compressor Startup Failure(code:"LC")

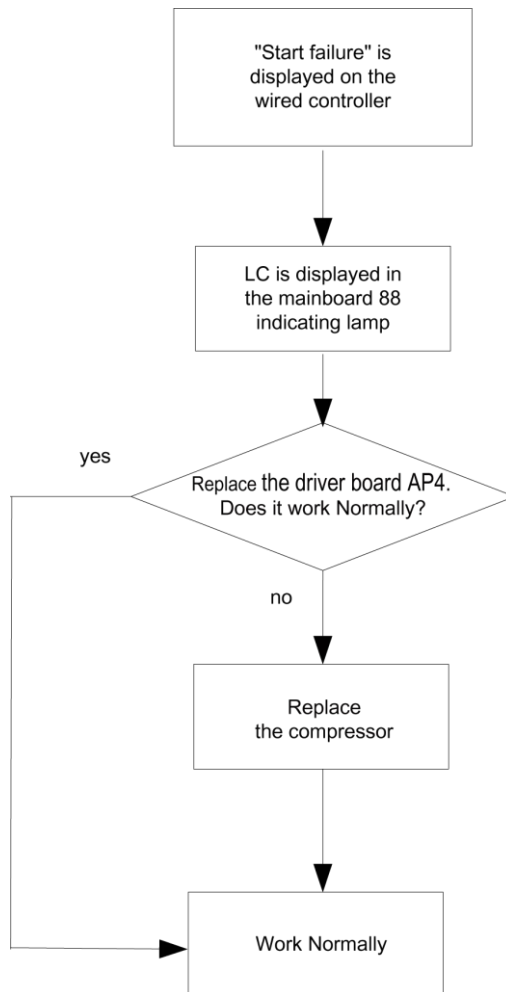

- ◆ Compressor Current Protection (Code:"P5"); Compressor Motor Desynchronizing (Code:"H7"); IPM Protection (Code:"H5"); Phase Loss (Code:"LD")

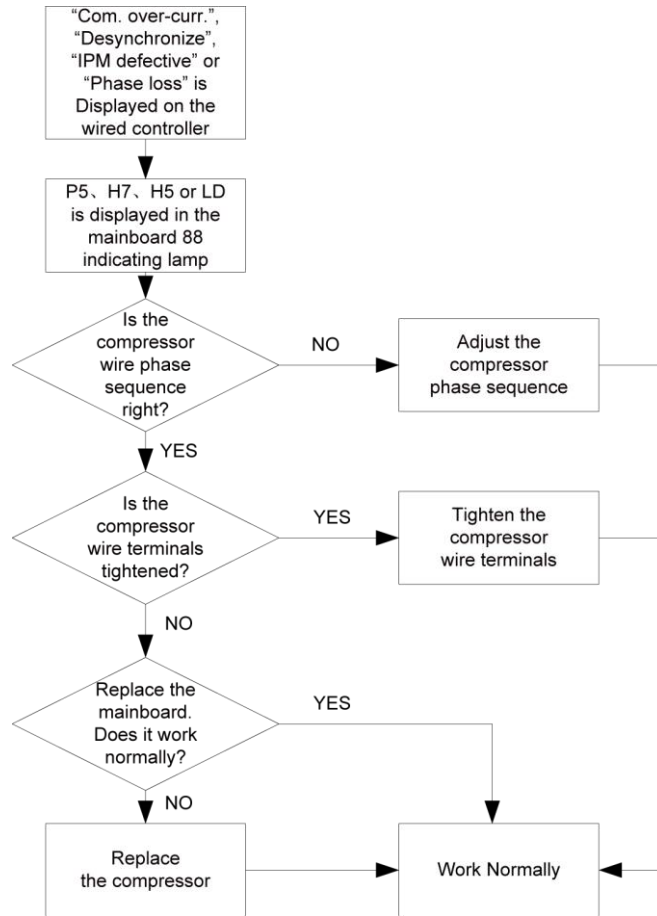

- ◆ Charging Circuit Error(Code:"PU")

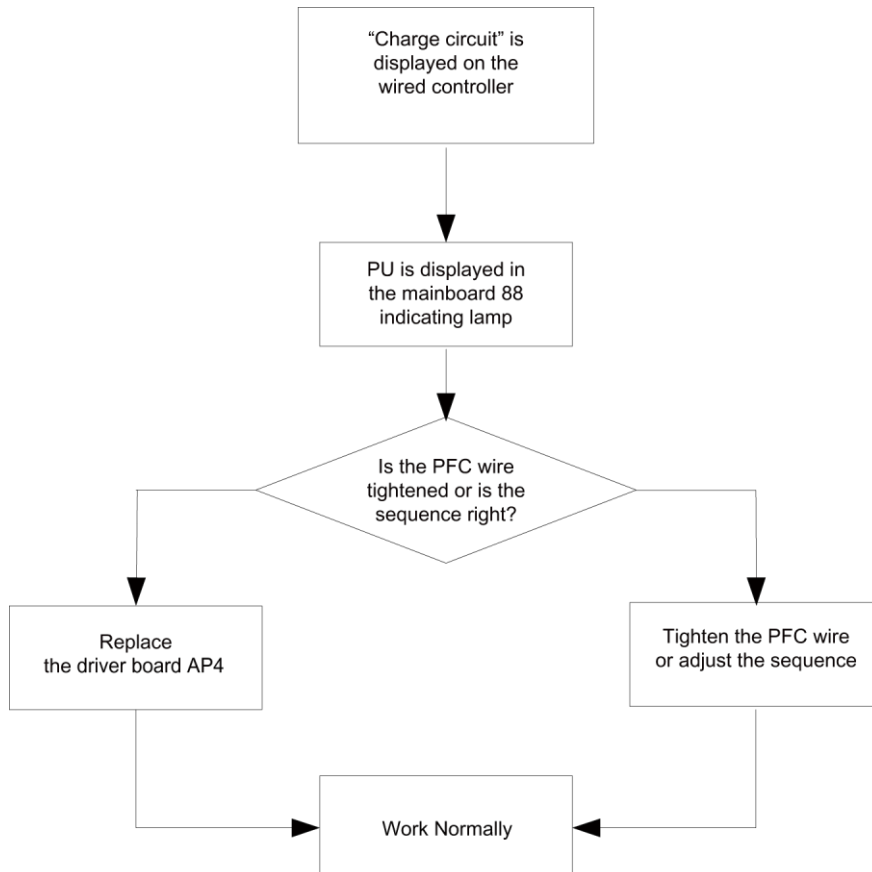

5 Daily Maintenance and Repair

5.1 Daily Maintenance

In order to avoid damage of unit, all protecting devices in the unit had been set before outgoing, so the user can never adjust or remove them.

For the first startup of the unit or next startup of unit after long-period stop (above 1 day) by cutting off the power, please electrify the unit in advance to preheat the unit for more than 8hr

Never put sundries on the unit and accessories. Keep dry, clean and ventilated around the unit.

Remove the dust accumulated on the condenser fin timely to ensure performance of unit and to avoid stop of unit for protection.

In order to avoid protection or damage of unit caused by blockage of water system, clean the filter in water system periodically and frequently check water replenishing device.

In order to ensure anti-freezing protection, never cut off the power if ambient temperature is below zero in winter.

In order to avoid frost crack of the unit, water in the unit and pipeline system not used for a long period should be drained. In addition, open the end cap of water tank for drainage.

Never frequently make the unit on/off and close manual valve of water system during operation of unit by users.

Ensure frequently check the working condition of each part to see if there is oil stain at pipeline joint and charge valve to avoid leakage of refrigerant.

If malfunction of the unit is out of control of users, please timely contact with authorized service center of company.

Note: the water pressure gage is installed in returning water line in the indoor unit, Please adjust the hydraulics system pressure according to next item:

- ① If the pressure is less than 0.5 bar, please recharge the water immediately;
- ② When recharging, the hydraulics system pressure should be not more than 2.5 Bar.

5.2 Troubleshooting





Malfunctions	Reasons	Troubleshooting
Compressor does not start up	<ul style="list-style-type: none"> ◆ Power supply has problem. ◆ Connection wire is loose. ◆ Malfunction of mainboard. ◆ Malfunction of compressor. 	<ul style="list-style-type: none"> ◆ Phase sequence is reverse. ◆ Check out and re-fix. ◆ Find out the reasons and repair. ◆ Replace compressor.
Heavy noise of fan	<ul style="list-style-type: none"> ◆ Fixing bolt of fan is loose. ◆ Fan blade touches shell or grill. ◆ Operation of fan is unreliable. 	<ul style="list-style-type: none"> ◆ Re-fix fixing bolt of fan. ◆ Find out the reasons and adjust. ◆ Replace fan.
Heavy noise of compressor	<ul style="list-style-type: none"> ◆ Liquid slugging happens when liquid refrigerant enters into compressor. ◆ Internal parts in compressor are broken. 	<ul style="list-style-type: none"> ◆ Check if expansion valve is failure and temp. sensor is loose. If that, repair it. ◆ Replace compressor.
Water pump does not run or runs abnormally	<ul style="list-style-type: none"> ◆ Malfunction of power supply or terminal. ◆ Malfunction of relay. ◆ There is air in water pipe. 	<ul style="list-style-type: none"> ◆ Find out the reasons and repair. ◆ Replace relay. ◆ Evacuate.
Compressor starts or stops frequently	<ul style="list-style-type: none"> ◆ Poor or excess refrigerant. ◆ Poor circulation of water system. 	<ul style="list-style-type: none"> ◆ Discharge or add part of refrigerant. ◆ Water system is blocked or there is air in





Test Operation & Troubleshooting & Maintenance



	<ul style="list-style-type: none"> ◆ Low load. 	<p>it. Check water pump, valve and pipeline. Clean water filter or evacuate.</p> <ul style="list-style-type: none"> ◆ Adjust the load or add accumulating devices.
The unit does not heat although compressor is running	<ul style="list-style-type: none"> ◆ Leakage of refrigerant. ◆ Malfunction of compressor. 	<ul style="list-style-type: none"> ◆ Repair by leakage detection and add refrigerant. ◆ Replace compressor.
Poor efficiency of hot water heating	<ul style="list-style-type: none"> ◆ Poor heat insulation of water system. ◆ Poor heat exchange of evaporator. ◆ Poor refrigerant of unit. ◆ Blockage of heat exchanger at water side. 	<ul style="list-style-type: none"> ◆ Enhance heat insulation efficiency of the system. ◆ Check if air in or out of unit is normal and clean evaporator of the unit. ◆ Check if refrigerant of unit leaks. ◆ Clean or replace heat exchanger.

5.3 Repair

5.3.1 Key Components

Picture	Name	Function
	<p>Compressor</p>	<p>It is the heart of the cooling system, mainly used to turn the low-temperature, low-pressure refrigerant vapor to high-temperature high-pressure vapor and then discharge it to the evaporator. The two-stage enthalpy-adding compressor is adopted herein, which can improve the heating performance of the unit largely.</p>
	<p>Electrostatic Expansion Valve</p>	<p>It is one of four main components and used to turn the hi-pressure liquid refrigerant to low-temperature, low-pressure vapor-liquid mixture and adjust the refrigerant flow rate entering the evaporator.</p>
	<p>Vapor Liquid Separator</p>	<p>It is installed at the side of the suction line, and used to prevent liquid refrigerant entering the compressor, which if not avoided will lead to wet compression or even liquid slugging.</p>
	<p>4-way Valve</p>	<p>It is used the switch flow direction of refrigerant and then realize switchover between cooling and heating. It also can be used for defrosting through the counterflow.</p>

Picture	Name	Function
	<p>Plate Heat Exchanger</p>	<p>It is the water-refrigerant plate type heat exchanger, used to liquefy the high-temperature high-pressure vapor refrigerant or evaporate the low-temperature low pressure liquid refrigerant. Heat of condensation is taken away by circulation water and heat for evaporation is supplied also by circulation water.</p>
	<p>Water Pump</p>	<p>It is the power equipment for water circulation.</p>
	<p>Expansion Tank</p>	<p>It is used to keep stable pressure of the water system. The tank is charged with a certain volume of nitrogen which is separated from the water side with a gasbag. When pressure of the water side exceeds the nitrogen pressure, the gasbag will expand and water enters into the tank so as to lower the pressure of the water system. In contract, when pressure of the water system goes down, nitrogen in the tank will expel water out to the water system.</p>
	<p>Flow Switch</p>	<p>It is used to prevent the heat exchanger from being frozen owing to reduced water flow rate. When the flow rate goes down to the point at which the flow switch will act, the switch will trip off and the unit will raise an alarm and shut down.</p>
	<p>Economizer</p>	<p>It is used in heating mode and water heating mode but NOT used in cooling mode. On one side, it can increase the subcooling before EXV, and on the other side it can enhance the refrigerant in heating circuit.</p>

Picture	Name	Function
	<p>Safety Valve</p>	<p>It is used to prevent the pressure of circulation water from increasing unusually. When the pressure is larger than the set point (0.3MPa), this valve will open to relieve water pressure.</p>
	<p>Exhaust Valve</p>	<p>It is used to expel air trapped inside the water system to make sure normal operation of the system. It is usually installed at the highest point of the system.</p>

5.3.2 Charging and Discharging of Refrigerant

The unit has been charged with refrigerant before delivery. Overcharging or undercharging will cause the compressor to run improperly or be damaged. When refrigerant is required to be charged or discharged for installation, maintenance and other reasons, please follow steps below and nominal charged volume on the nameplate.

Discharging: remove metal sheets of the outer casing, connect a hose to the check valve on outdoor unit and then discharge refrigerant:

Note:

- (a) Discharge is allowed unless the unit has been stopped. (Cut off the power and repower it 1 minutes later)
- (b) Protective measures should be taken during discharging to avoid frost bites.
- (c) When discharging is finished, if vacuuming cannot be done immediately, remove the hose to avoid air or foreign matters entering the unit.
- (d) **Vacuuming:** when discharging is finished, use hoses to connect the charging valve, manometer and vacuum pump to vacuum the unit.

Note:

When vacuuming is finished, pressure inside the unit should be kept lower than 80Pa for at least 30 minutes to make sure there is no leak. Either charging valve 1 or charging valve 2 can be used for vacuuming.

Charging: when vacuuming is finished and it is certain that there is no leak, charging can be done.

Leak Detection Methods:

The following leak detection methods are deemed acceptable for systems containing flammable refrigerants.

Electronic leak detector shall be used to detect flammable refrigerant, but the sensitivity may not be adequate, or may need re-calibration (Detection equipment shall be calibrated in a refrigerant-free area). Ensure that the detector is not a potential source of ignition and is suitable for the refrigerant used.

Leak detection equipment shall be set at a percentage of the LFL of the refrigerant and shall be calibrated to the refrigerant employed and the appropriate percentage of gas (25% maximum) is confirmed.

Leak detection fluids are suitable for use with most refrigerant but the use of detergents containing chlorine shall be avoided as the chlorine may react with the refrigerant and corrode the copper pipe-work.

If a leak is suspected, all naked flames shall be removed / extinguished. If a leakage of refrigerant is found which requires brazing, all of the refrigerant shall be recovered from the system, or isolated (by means of shut off valves) in a part of the system remote from the leak. Oxygen free nitrogen (OFN) shall then be purged through the system both before and during the brazing process.

Note:

Before and during operation, use an appropriate refrigerant leak detector to monitor the operation area and make sure the technicians can be well aware of any potential or actual leakage of inflammable gas. Make sure the leak detecting device is applicable to inflammable refrigerant. For example, it should be free of sparks, completely sealed and safe in nature.

NOTE CONCERNING PROTECTION OF ENVIRONMENT



This product must not be disposed of via normal household waste after its service life, but must be taken to a collection station for the recycling of electrical and electronic devices. The symbol on the product, the operating instructions or the packaging indicate such disposal procedures. The materials are recyclable in accordance with their respective symbols. By means of re-use, material recycling or any other form of recycling old appliances you are making an important contribution to the protection of our environment. Please ask your local council where your nearest disposal station is located.

INFORMATION CONCERNING USED REFRIGERANT MEDIUM

This unit is containing fluorinated gases included in the Kyoto protocol. The maintenance and the liquidation must be carried out by qualified personnel.

Type of refrigerant: R32

The quantity of the refrigerant: please see the unit label.

The value GWP: 675 (1 kg R32 = 0,675 t CO₂ eq)

GWP = Global Warming Potential



Appliance filled with flammable gas R32.

In case of quality problem or other please contact your local supplier or authorized service center.

Emergency number: 112

PRODUCER

SINCLAIR CORPORATION Ltd.

1-4 Argyll St.

London W1F 7LD

Great Britain

www.sinclair-world.com

This product was manufactured in China (Made in China).

REPRESENTATIVE

SINCLAIR Global Group s.r.o.

Purkynova 45

612 00 Brno

Czech Republic

TECHNICAL SUPPORT

SINCLAIR Global Group s.r.o.

Purkynova 45

612 00 Brno

Czech Republic

Tel.: +420 800 100 285

Fax: +420 541 590 124

www.sinclair-solutions.com

info@sinclair-solutions.com

